



# Specialized Tools & Filtration



# Table of contents

<b>Specialized Tools</b>	<b>2</b>	<b>Riser Cleaning Tools</b>	
<b>Liner Top Test Tools</b>		PUP RISER BRUSH (PRB)	35
WELL COMMISSIONER (WC)	2	RISER CLEANING TOOL (RCT)	36
<b>Casing Cleaning Tools</b>		RISER DISPLACEMENT CLEANING TOOL (RDCT)	37
BRISTLE BACK REDRESSABLE	4	<b>BOP Cleaning Tools</b>	
MULTIBACK (MBACK)	5	DUAL-ACTION BYPASS	
Heavy-Duty RAZOR BACK (HDRB)	6	SUB JETTING TOOL (DABS-JT)	38
RAZOR BACK (RB)	8	SINGLE-ACTION BYPASS	
RAZOR BACK with		SUB JETTING TOOL (SABS-JT)	39
Integral Top Dress Mill (RBTDM)	10	SHORT TRIP JETTING SUB (STJS)	40
RIDGE BACK Burr Mill (RBBM)	11	<b>Wellhead Cleaning Tools</b>	
SWITCHBACK (SWB)	13	WELLHEAD BRUSHING/JETTING TOOL	41
<b>Circulating Tools</b>		<b>Ancillary Tools</b>	
Clutch-Type, Heavy-Duty MULTI-FUNCTION		BYPASS BALL CATCHER (BBC)	42
CIRCULATING TOOL (MFCT-HD)	14	LANDING SUB (LS)	43
DUAL-ACTION BYPASS SUB (DABS)	16	POSI-DRIFT SUB (PDS)	44
Clutch Type, MULTI-FUNCTION		<b>Customized Tools</b>	
CIRCULATING TOOL (MFCT)	17	BEARING SUB (BS)	45
PORTED BYPASS SUB (PBS)	18	DISENGAGEABLE MILL ASSEMBLY (DMA)	46
SINGLE-ACTION BYPASS SUB (SABS)	19	Disposable BRISTLE BACK (DBB)	47
WELL COMMANDER	20	PRESSURE SHEAR SUB (PSS)	48
WELL ISOLATION TOOL (WIT)	23		
<b>Debris Recovery Tools</b>		<b>Filtration</b>	<b>50</b>
JUNK MUNCHER (JM)	24	Completion Fluids Filtration	50
MAGNOSHOE (MSHOE)	25	DE Filtration Units plate and frame skid	54
MAGNOSTAR (MSTAR)	26	Equipment	58
MAGNOSTAR Heavy Duty (MSTAR HD)	27	Filter Press Package (Unit)	59
MAGNOSWEEP II (MSWEEP II)	28	FILTER FLOC	59
SWITCHBACK MAGNET (SWBM)	29	SAFE-FLOC I	60
WELL PATROLLER (WP)	30	SAFE-FLOC II	61
WELL PATROLLER 500 Series	32		
WELL PROTECTOR (WPR)	33		
WELL SCAVENGER (WS)	34		

# WELL COMMISSIONER (WC)

## Specialized Tools: Liner Top Test Tools

The WELL COMMISSIONER\* tool from M-I SWACO is unique in that it is designed to allow inflow and negative tests to be carried out on a liner overlap and the liner shoe track on the same trip as the wellbore cleanup. It can also be used to perform an inflow or negative test on the liner top and liner shoe track at any time during the life of the well. Regardless of when the tool is run, it results in significant savings in rig time compared to other methods of performing an inflow test. Significant reduction in oil-contaminated seawater or brine volumes generated is also possible where OBM is in use.

### Advantages

The WELL COMMISSIONER tool eliminates the need for a controlled displacement of the entire well to lower density fluid through the choke with the blowout preventers closed. It also eliminates a dedicated run with a retrievable packer to perform the test, saving significant rig time. Positive tests on the casing or liner can also be carried out. Significant reduction in waste volumes of contaminated fluids is also made.

### Features

- One-piece mandrel
- Integral RAZOR BACK (scraper) lantern
- Integral liner-top dress mill
- Internal bypass under packoff element
- Standard tool rated to 5,000 psi (345 bar) differential up to 302°F (150°C)
- High-pressure tool rated to 7,000 psi (483 bar) differential up to 302°F (150°C)

### How it works

The WELL COMMISSIONER tool is run on the drillstring, spaced out to land on the liner-top Polished-Bore Receptacle (PBR) when the cleanout string is at final depth. The integral RAZOR BACK\* lantern cleans ahead of the packoff element and prepares the area in which the tool itself is to be set. The bypass under the element is open while running in hole and allows high-rate circulation without the need for fluids to go around the outside of the element (Figure 1).

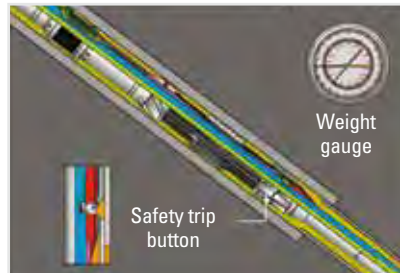

Figure 1. Pick up off the liner and begin circulating and conditioning the mud.

### Advantages

- Saves rig time and improves effectiveness of cleanup
- Simple to operate
- Allows inflow/negative test on same trip as cleanup
- Allows drilling and milling with tool in string
- Reduces waste volumes



## Operation

When the integral liner-top dress mill lands on the PBR, it can be used to dress off the PBR top if required. A tieback mill can be run below the tool to clean inside the PBR.

A low-density water- or oil-base fluid is then pumped into the upper portion of the drill pipe to reduce the hydrostatic pressure on the liner overlap and liner shoe track. While back pressure on the drill pipe is held, the tool is set down on the liner top, the packoff element is set and the bypass closed. Back pressure bleed-off is the inflow test performed by monitoring for an increased pressure in the drill pipe, indicating inflow (Figure 2). When the test is complete, repressurize to the previous back pressure, pick up to release the packoff element and open the bypass. The normal cleanup and displacement to completion fluid can now be conducted.

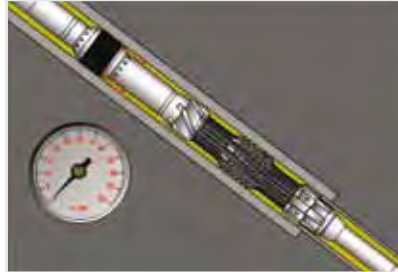

Figure 2. Slowly bleed down the work-string pressure to begin the inflow test.

The MULTI-FUNCTION CIRCULATING TOOL\* (MFCT) can be run above the liner top to boost circulation rates.

## Operating Parameters

If an MFCT unit is proposed in the same string as the WELL COMMISSIONER tool, M-I SWACO will perform a torque and drag analysis to verify the effective tension in the string at the liner top while tripping in hole at 150 ft/min (46 m/min) without rotation.

When a WELL COMMISSIONER tool is run in conjunction with an MFCT unit, at least 10,000 lb (4,536 kg) effective string weight (tension) should be available below the tool when it is at operating depth. If this is not the case, consideration should be given to increasing the shear rating on the MFCT unit or running a Clutch-Type, Heavy-Duty MFCT unit or adding drill-collar weight to the string below.

It is recommended that a tieback mill is run below the WELL COMMISSIONER tool to polish the inside of the tieback receptacle of the PBR. This reduces the risk of a cement sheath, or other debris buildup, preventing the tool from seating on top of the tieback receptacle or PBR. Maximum running-in-hole/pulling-out-of-hole speed is 150 ft/min (46 m/min). The required inflow test pressure can only be achieved, if the resulting loading on the liner hanger system is within operating guidelines.

## Operating parameters

Tool (casing) size, in.	Maximum rotating speed in tension, rpm	Maximum rotating speed in compression, rpm	Maximum compression at tool when rotating, lb (kg)
7 – 8 $\frac{1}{8}$	100	60	5,000 (2,268)
9 $\frac{1}{8}$ – 10 $\frac{1}{4}$	120	90	10,000 (4,536)

These are general guidelines only and are subject to review, if required, for individual circumstances.

# BRISTLE BACK REDRESSABLE

## Specialized Tools: Casing Cleaning Tools

The BRISTLE BACK REDRESSABLE\* brush tool utilizes a unique lantern design that provides greater bristle life. This lantern design also allows easy, remote location redressing when required, saving time and delivering a higher level of service. The tool's effective, robust, and flexible design allows for complex, precompletion/ Drill-Stem Test (DST) and workover cleanup operations.

### Features

- Brush cleaning life prolonged during rotation
- Self-centralizing, flexible-brush lantern
- Available in all common casing/liner sizes
- Supplied with drill-pipe box-up/ pin-down connections
- Brush pads can easily be replaced on location

### Applications

The BRISTLE BACK REDRESSABLE brush is run as an integral part of the drillstring to brush the casing ID clean as the pipe is run in hole. It can be run as part of most drilling/milling/ polishing assemblies and can be rotated and reciprocated without damage to either the casing or the tool.

### Advantages

- Scouring action ensures a clean pipe wall
- Non-rotating stabilizer sleeves and lantern avoid wear or damage to the casing and the tool bristles during pipe rotation
- Self-centralizing lantern distributes cleaning force equally for all hole inclinations
- Removes mud solids, cement sheath and pipe scale
- Saves time and inventory requirements



# MULTIBACK (MBACK)

## Specialized Tools: Casing Cleaning Tools

The MULTIBACK\* (MBACK) combination casing cleaning tool merges the latest proven magnet, scraper, and brush technologies into a simplified and rugged tool that can be used on wellbore preparation trips. The flexibility of the component arrangement provides numerous options to customize the tool for a specific application.

### Applications

The modular design of the MULTIBACK tool allows it to be configured for specific applications or requirements. The MULTIBACK tool has an integral magnet section to capture ferrous debris, scrapers to dislodge difficult-to-remove debris, and brushes to disturb the sheath and any other fluid build-up on the inner wall of the casing or liner. The tool can be run in the inner production riser, casing, and liner to remove a combination of scale, rust, mud film, drilling debris, ferrous debris, and pipe dope.

### Features

- One tool carries scrapers, brushes, or magnets on the same mandrel
- Large flow area between magnets to capture large debris
- BRISTLE BACK REDRESSABLE\* brush component can be readily redressed at remote locations

### How it works

The MULTIBACK tool is run in the well as a conventional wellbore preparation tool on the workstring. The lanterns for the scraper and brush unit are flexible, non-rotating, and provide the force to contact and clean 360° of the casing's internal diameter. Its self-centralizing design ensures equal cleaning force at all angles of inclination. The magnet section comprises a mandrel with fins that allow for large flow channels between them. The magnets are installed on the inside faces of the fins using a method for retaining the individual magnets so that the debris is collected in the high volume channels. The magnet section is integral in the tool while the scraper and brush sections are interchangeable.

### Advantages

- MULTIBACK combination tool provides brushing, scraping and magnetic debris recovery
- Scouring action of brush and scraping action of scraper removes cement sheath, burrs, and pipe scale to ensure a clean pipe wall
- Self-centralizing lanterns distribute cleaning force equally for all hole inclinations
- No risk of casing wear or damage from rotating stabilizers or lanterns
- Large capacity for up to 67 lb (41 kg) of ferrous material retrieval
- Recovered debris from magnets removed easily on location



# Heavy-Duty RAZOR BACK (HDRB)

## Specialized Tools: Casing Cleaning Tools

The Heavy-Duty RAZOR BACK\* (HDRB) tool from M-I SWACO consists of a high-strength, one-piece mandrel and is designed to meet the demands of complex wellbore cleanups. By allowing a higher RPM and weight-on-bit rating than the standard RAZOR BACK device, the Heavy-Duty RAZOR BACK unit is well suited for drilling up cement accessories commonly found inside the liner or casing.

### Advantages

The Heavy-Duty RAZOR BACK device is more effective, robust and safer to use in all wellbore-cleanup or casing-scraping operations than other designs. It has a higher RPM and weight-on-bit rating than the standard RAZOR BACK unit.

The lantern is self-centralizing inside the pipe to ensure equal cleaning force at all angles of well inclination. The mandrel

rotates through the stabilizer sleeves and lantern to avoid wear or damage to the casing during pipe rotation. The tool is HTHP-compatible and is not vulnerable to chemical or acid attack.

### Operation

The Heavy-Duty RAZOR BACK device is run with a maximum running-in-hole/pulling-out-of-hole speed of 150 ft/min (46 m/min) and should be positioned at least 30 ft (9 m) above the drill bit/mill. The string should be picked up off-bottom and circulated regularly to clear any accumulation of debris.

Where possible, the bit or mill OD should be greater than the stabilizer sleeve OD of the tool. If this is not possible, it is recommended that a full-gauge mill be run below the first Heavy-Duty RAZOR BACK unit in the bottomhole assembly.

### Features

- Self-centralizing flexible-bladed lantern
- Increased strength, one-piece main mandrel
- Carbide-compound-covered, fixed-mill rings
- Available in all common casing and liner sizes
- Supplied with drill-pipe box-up/pin-down connections

### Advantages

- Fixed-mill rings enhance efficiency when drilling cement accessories
- Lower mill ring ensures larger cuttings are ground down to a size that is manageable for other cleanup tools in the string
- Mandrel rotates through stabilizer sleeves and lantern to avoid damage to casing during pipe rotation
- Lantern is self-centralizing inside casing and ensures an equal cleaning force for all hole inclinations





## How it works

This tool has all the unique features of the standard RAZOR BACK device, plus a carbide-compound coated fixed upper and lower mill ring and an increased-strength, one-piece mandrel. This ensures the tool can cope with the demands of drilling up cement accessories commonly found inside the liner or casing. When a drill bit or mill is used, cuttings generated are not always small enough to easily pass inside or around wellbore-cleanup tools. The lower mill ring of the Heavy-Duty RAZOR BACK unit ensures that larger cuttings and debris are ground down

to a size that makes it easier for them to circulate past any other tools in the string.

The one-piece, main mandrel is complete with non-rotating, right-hand spiral stabilizer sleeves and a metal-bladed lantern covering 360°. The main tool body rotates through the stabilizer sleeves and lantern, avoiding wear or damage to the casing during pipe rotation. The metal-bladed lantern is strong, flexible and self-centralizing, providing the force to contact and scrape the pipe ID equally and effectively.

### Operating parameters

Tool (casing) size, in.	Maximum rotating speed in tension, rpm	Maximum rotating speed in compression, rpm	Maximum compression at tool when rotating, lb (kg)
4½ – 5½	90	60	30,000 (13,608)
7 – 7½	100	60	35,000 (15,876)
9½ – 11¼	120	90	50,000 (22,680)
13¾	120	100	55,000 (24,948)

These are general guidelines only and are subject to review, if required, for individual circumstances.

# RAZOR BACK (RB)

## Specialized Tools: Casing Cleaning Tools

This new-generation improvement in metal-bladed scraper design brings even the most complex wellbore cleanups under control. The RAZOR BACK\* (RB) tool has critically important features not found on any other metal-bladed casing scraper that render it more effective, more robust and safer to use in wellbore cleanup and casing scraping operations.

### Advantages

The lantern is self-centralizing inside the tubular to ensure equal cleaning force at all angles of well inclination. The mandrel rotates through the stabilizer sleeves and lantern to avoid wear or damage to the casing during pipe rotation. The tool is HTHP-compatible and is not vulnerable to chemical or acid attack.

### Operation

The RAZOR BACK unit is run with maximum running-in-hole/pulling-out-of-hole speed of 150 ft/min (46 m/min), and should be positioned at least 30 ft (9 m) above the drill bit/mill and placed so that

it does not pass through any drilled-out accessories such as landing or float collars. The string should regularly be picked up off-bottom and circulated to clear any accumulated debris.

Where possible, the bit or mill OD should be greater than the stabilizer sleeve OD of the RAZOR BACK device. If this is not possible, it is recommended that a full-gauge mill be run below the first RAZOR BACK unit in the bottomhole assembly. It is not recommended to drill cement with a small RAZOR BACK (3½ to 5½ in.) device. Alternatively, it is suggested that a dedicated slick-drilling run be made first to drill out the excess cement and establish Plug Back Total Depth (PBDT) prior to the cleanup run. Should a slick run not be possible, a Heavy-Duty RAZOR BACK unit is recommended.

### Features

- Non-rotating, 360° coverage, self-centralizing metal-bladed lantern
- Right-hand spiral stabilizer sleeves with flutes for fluid and debris bypass
- Available in all common casing and liner sizes
- Supplied with drill-pipe box-up/pin-down connections

### Advantages

- Removes cement sheath, burrs, pipe scale
- Eliminates risk of casing wear/damage from stabilizers or blades during rotation
- Enhances chemical cleaning action



## How it works

The RAZOR BACK tool from M-I SWACO is run as an integral part of the drillstring to scrape the casing as the pipe is run in hole. It can be run as part of most drilling/milling/polishing assemblies, as a standalone device or, more often, with circulating tools and the WELL PATROLLER\* tool as part of

the cleanup system. It can be rotated and reciprocated without fear of damage to casing or the tool itself.

The RAZOR BACK device consists of a one-piece main mandrel complete with non-rotating, right-hand spiral stabilizer sleeves and a metal-bladed lantern covering 360°. The metal-bladed lantern is both strong and flexible,

and provides the force to contact and scrape the pipe ID effectively. While running in hole, it is good practice to break circulation and reciprocate the pipe regularly (every 5,000 ft [1,524 m]) to disperse and enhance the cleanup of any debris buildup.

### Operating parameters

Tool size	Maximum rotating speed in tension, rpm	Maximum rotating speed in compression, rpm	Maximum compression at tool when rotating, lb (kg)
3½	60	60	3,000 (1,361)
3½ – 5½	90	60	5,000 (2,268)
6½ – 8½	100	60	10,000 (4,536)
9½ – 13½	120	90	15,000 (6,804)
16	120	90	50,000 (22,680)

These are general guidelines only and are subject to review, if required, for individual circumstances.

# RAZOR BACK with Integral Top Dress Mill (RBTDM)

## Specialized Tools: Casing Cleaning Tools

The RAZOR BACK\* (Casing Cleanup Tool) with Integral Top Dress Mill (RBTDM) tool from M-I SWACO ensures that the casing is scraped to a point very close to the top of the liner so that subsequently installed liner-top tieback packers will be set and sealed in a clean, properly prepared section of casing.

### Applications

This tool is designed as a mechanical aid for cleaning wellbore casings and dressing liner-top Polished-Bore Receptacles (PBRs). The tool is HTHP-compatible and not vulnerable to chemical or acid attack. It can be run as a standalone device or in conjunction with circulating tools, BRISTLE BACK\* units and chemical cleaning agents. The RAZOR BACK unit is very robust and effective in removing mud solids, heavy cement sheath, heavy pipe scale and perforation burrs from the casing ID, in addition to dressing off the liner-top PBR.

### How it works

The RAZOR BACK device consists of a one-piece body, a non-rotating stabilizer sleeve, a non-rotating scraping bladed lantern, and an integral liner-top dress mill. The body rotates through the upper stabilizer sleeve to avoid wear/damage to the casing during pipe rotation. The bladed lantern is strong and flexible and provides the force to contact and clean 360° of the pipe ID. The lantern is self-centralizing inside the pipe to ensure equal cleaning force at all angles of inclination. No clamps, bolts, threaded rings, springs or multiple scraper blocks that may be lost downhole are used in tool construction.

### Features

- Secure components
- Self-centralizing, flexible-blade lantern
- Available in all common casing-liner sizes; complete with top dress mill for all common PBR sizes
- Supplied with drill-pipe box-up/pin-down connections

### Advantages

- Removes cement and mud solids, burrs, pipe scale
- Enhances chemical cleaning action
- Scrapes casing very close to the liner top



# RIDGE BACK Burr Mill (RBBM)

## Specialized Tools: Casing Cleaning Tools

The RIDGE BACK\* Burr Mill (RBBM) tool is a M-I SWACO casing cleanup tool developed for use in perforated casing or liner to remove perforation burrs and to ensure the safe passage of completion equipment.

### Advantages

A unique feature of the RIDGE BACK Burr Mill tool is the ability to turn it off once the milling/cleaning operation is complete if other extensive rotation is anticipated before pulling out of the hole. This is achieved by circulating a ball down, and shifting an internal support sleeve, to remove the expanding force on the milling ribs. These ribs are then held recessed into the tool and away from the pipe ID.

Full circulation through the ID of the tool is possible before and after the support sleeve is moved. The tool can also be used to clear off equally stubborn

ID-restricting materials (e.g., heavy pipe scale) from the inside of casing/liner to regain full pipe ID.

### Operation

At least one MAGNOSTAR\* tool should be run above the RIDGE BACK Burr Mill tool to collect the milled material. In addition, consideration should be given to running a RAZOR BACK\* tool and a WELL PATROLLER\* unit above the top MSTAR tool. It should be run at a maximum run-in-hole/pull-out-of-hole speed of 150 ft/min (46 m/min). If the string is to be rotated at the same depth for more than 30 min, it is recommended that the RIDGE BACK Burr Mill unit be deactivated. This is achieved by dropping and circulating a ball to the tool and applying pressure to shift the internal support sleeve. It should be noted that when the tool is deactivated, it cannot be reactivated.

### Features

- One-piece mandrel
- Cleans by rotation and up/down pipe movement
- Supplied with drill-pipe box-up/pin-down connections
- Available in all common casing/liner sizes
- Milling ribs can be deactivated by ball drop to minimize casing wear during periods of prolonged rotation

### Advantages

- Provides advanced wellbore cleanup in the post-perforating well phase, where a high degree of casing or liner ID smoothness through the perforated interval is required
- Completely removes perforation burrs, preventing damage to completion equipment, including expandable screens/expandable pipe used in complex/smart completions
- Capability to turn off tool once the milling/cleaning operation is complete to avoid casing wear



### How it works

The RIDGE BACK Burr Mill tool is built on a one-piece drill-pipe mandrel and is equipped with three expandable milling ribs that make contact with the full ID of the casing/liner. The right-hand face of the milling rib is dressed with a carbide compound so that the expanding force, coupled with right-hand rotation, ensures perforation burrs are removed from the ID of the pipe. The lower end of the tool has a fixed-mill sleeve (Figure 1), also dressed with a carbide compound to remove a proportion of the perforation burrs before the expandable mill ribs remove the remainder of the burrs to reinstate the full pipe ID. The upper end of the tool

has a fixed stabilizer sleeve to provide balanced support to the mill ribs. Removal of perforation burrs is achieved by running in hole and pulling out of hole through the perforated interval at a predetermined speed

(10 ft/min [3 m/min]), while rotating at the recommended 60 rpm. This ensures sufficient contact time between the mill ribs and each perforation to effectively remove all burrs and leave the pipe ID smooth and free of restrictions.



Figure 1. Lower fixed mill sleeve.



Figure 2. Burrs on tubular ID prior to cleaning with RIDGE BACK Burr Mill.

### Operating parameters

Tool size, in.	Maximum rotating speed in compression, rpm	Maximum rotating speed in tension (activated), rpm	Maximum rotating speed in tension (deactivated), rpm	Deactivation pressure, psi (bar)
7 – 8 <sup>1</sup> / <sub>16</sub>	60	60	100	1,800 (124)
9 <sup>5</sup> / <sub>8</sub> – 10 <sup>3</sup> / <sub>4</sub>	60	60	120	830 (57)

These are general guidelines only and are subject to review, if required, for individual circumstances.

# SWITCHBACK (SWB)

## Specialized Tools: Casing Cleaning Tools

The SWITCHBACK\* (SWB) casing cleaning tool is versatile and can be configured as a scraper, brush or mill. It can be run as an integral part of the BHA while drilling the final hole section multiple tools can be run in a single string that allows scraping, brushing, milling, or a combination of all three operations. While RIH and during drilling operations the component pads are recessed. Once drilling operations have reached TD the SWITCHBACK tool can be functioned by dropping a ball and applying pressure. As the ball shears through the tool the pads extend to begin the clean up operation.

### Features

- Modular design allows flexibility among scraping, brushing and milling modes
- High torque, rugged design for use in demanding applications
- Recessed blades that are RIH in dormant position
- Activated by ball-drop using patented ball seat technology
- Cleaning action in rotation, force exerted on casing ID by magnetic repulsion of pads
- Integral stabilizer to provide standoff – fluted design for maximized bypass
- Innovative pad retention mechanism
- Pads locked in dormant or engaged positions

### Applications

The SWITCHBACK unit can be utilized in situations where sand screens are being used, a packer setting area needs to be cleaned or while milling a perforation interval. By having the tool properly located in the drilling BHA, the targeted casing section can then be cleaned and prepared for the subsequent operation without making a dedicated cleanup trip.

### Advantages

- Saves a trip by allowing scraping, milling or brushing of lower completion packer setting areas during final hole section drilling
- The dormancy feature (pads recessed until activated) greatly reduces risk of pack-off around tool blades during drilling
- Patented ball seat technology enables multiple tools, all activated by the same ball, to be run in the same string saving rig time
- Disperses accumulated cuttings beds through a combination of hydraulic and mechanical actions, particularly when used with the WELL COMMANDER\* drilling valve
- Generous bypass flow area minimizes ECD increases



# Clutch-Type, Heavy-Duty MULTI-FUNCTION CIRCULATING TOOL (MFCT-HD)

## Specialized Tools: Circulating Tools

The Clutch-Type, Heavy-Duty MULTI-FUNCTION CIRCULATING TOOL\* (MFCT-HD) from M-I SWACO is a valuable option when well cleanout is required in deeper, deviated wells and/or when it is necessary to start and stop the cleanout operation at several places in the wellbore.

### Applications

This tool is an enhanced version of the original MFCT device and is suited for use in deeper, deviated wells where there is a requirement for higher tensile and torsional ratings. It is also applicable when it is desirable to lock this type of circulating tool in the open/closed position, such as performing an inflow test on a liner lap.

The Clutch-Type, Heavy-Duty MFCT unit has the same basic functionality as the original version. It allows higher circulation rates to be achieved at various times during a wellbore cleanup to displace debris or fluid out of the hole.

It also allows flow rates to be boosted at a liner top to increase the annular velocity of the wellbore fluid, thereby increasing the cleaning action. The tool is particularly suited to wells with small liner diameters in which well-cleanup operations are performed prior to running completions or test strings. The tool can be run when drilling cement and milling/polishing liner-top PBRs.

The use of this tool also allows the spotting of chemical pills and the efficient displacement of wellbore fluids. In addition, it offers the benefit of pipe rotation and circulation above a liner, with the jetting ports open, while protecting the lower string from potentially damaging torque. When the tool is open, only the drillstring above the tool can be rotated. When the tool is closed, the complete string can be rotated with circulation directed through the bit or mill.

### Features

- Does not require darts or balls to be pumped down the drill pipe
- Can be cycled open and closed in the hole as many times as required by simply slacking off/picking up the drill pipe
- Allows drilling/milling to take place with the tool in the string
- Internal clutch for drillstring rotation above the tool with the circulating ports open
- Can be locked closed in compression to avoid premature opening while RIH; can be locked open in tension to allow the tool to be picked up off the liner top while continuing to circulate at high rates

### Advantages

- Allows flow rates to be boosted at a liner top to increase the annular velocity of the wellbore fluid, thereby increasing cleaning action
- Allows spotting of chemical pills and efficient displacement of wellbore fluids
- Gives the benefit of pipe rotation and circulation above a liner with the ports open, while protecting the lower string from potentially damaging torque





## How it works

The Clutch-Type, Heavy-Duty MFCT device is run with a suitable no-go device (liner-top dressing mill, bearing sub or stabilizer) below it, allowing it to be operated without putting the lower string in compression. No darts or balls need to be pumped down the drill pipe, and the tool can be operated in the hole as many times as required by simply slacking off/picking up the string. When Running In Hole (RIH), the tool is fully stroked out, with all circulation passing through the end of the drillstring. In this initial position, rotating torque is transmitted to the whole drillstring. The tool has shear screws installed to ensure that it will not open prematurely while RIH. If the shear screws are inadvertently sheared by high drag forces, the tool will remain closed and RIH can continue without any further action being taken.

To operate the Clutch-Type, Heavy-Duty MFCT device, the driller sets the tool down and applies the required weight to shear the screws. When the screws are sheared, the outer body of the tool moves down a short distance, putting the tool into the "locked-closed" position. The string is then picked up and slacked off again to move the outer body down the full stroke length, putting the tool in the open position. High circulating rates can now be achieved through the circulating ports. If required, the tool can be picked up off the liner top into the "locked-open" position. Rotation is still not transmitted below the tool in this position. To close the tool, the string is slacked off and picked up once again, returning it to the original closed position. The tool can be opened and closed as many times as required by manipulating the string.

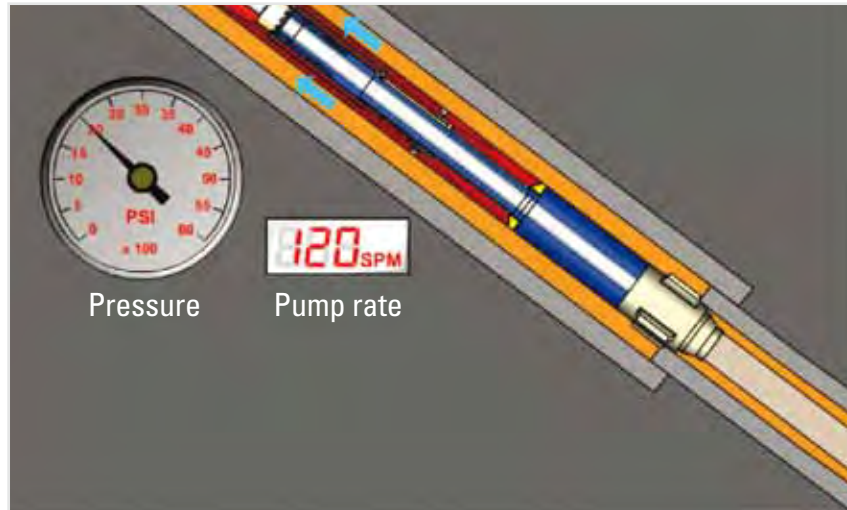

Figure 1. Slack off onto the liner top without circulation with sufficient weight to shear the shear ring and open the circulation ports. Check circulation rates to establish that the tool is open.

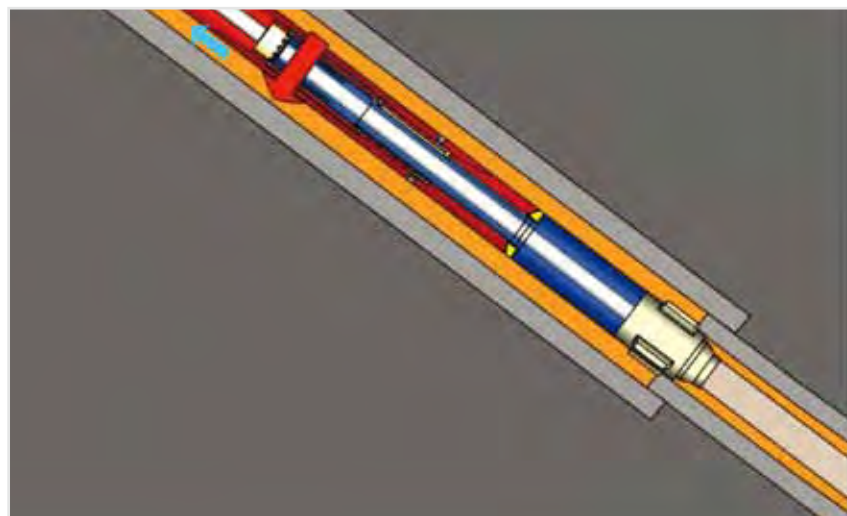

Figure 2. Slack off onto the liner top without circulation to open the tool. Displace the drill-pipe/casing annulus and rotate the string. Note that the clutch is now disengaged and only the upper string is rotated in this position.

# DUAL-ACTION BYPASS SUB (DABS)

## Specialized Tools: Circulating Tools

The DUAL-ACTION BYPASS SUB (DABS) tool from M-I SWACO is designed to run in the cleanup string when it is desirable to jet the riser and Blowout Preventer (BOP) while Running In Hole (RIH) and/or when Pulling Out Of Hole (POOH). It can also be used nearer the bottom of the string as a bypass valve above a drilling motor or small-diameter tail pipe.

### Advantages

The DABS tool permits jetting operations while running in hole and/or when pulling out of hole.

### Operating Parameters

Note that the balls do not need to be circulated down at this reduced rate. It is only when the ball nears the ball seat that these rates should be applied (see table below).

Operating parameters			
Tool size, in.	Rotating speed	Maximum circulating rate when landing balls, gpm (bbl/min)	Maximum circulating rate in the open position, bbl/min
3½ IF	No limit	63 (1.5)	15
4½ IF	No limit	105 (2.5)	30
XTM50	No limit	105 (2.5)	30

These are general guidelines only and are subject to review, if required, for individual circumstances.



### Features

- One-piece, full-strength mandrel
- Two sets of ports and two internal ball seats that can be moved to open/close ports
- Available in 4¾ and 6½ in. OD
- Also available as 11 and 16 in. (279 and 406 mm) jetting tools

### Advantages

- Used to jet BOPs and risers
- Can be used to bypass drilling motors
- Can be run above small, non-draining pipe

### Operation

The DABS unit is RIH with the cleanup string, self-filling through the open ports and circulating/jetting as required. A ball is dropped to close the ports, then drilling or circulating occurs as required (Figure 1). Dropping another ball opens the ports to trip out which allows self-draining and circulation/jetting to take place as required (Figure 2).

### How it works

The tool is run in the open position to jet and clean as it moves through the riser and BOPs. The external jetting ports on the sub are then closed to circulate once again, and reopened when POOH, allowing jetting to occur.

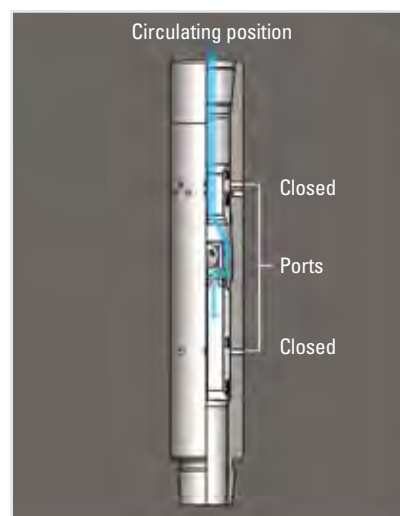

Figure 1. The lower ports are closed by dropping a ball and applying pressure.

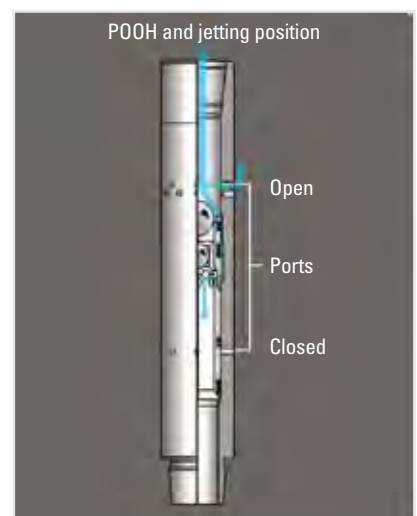

Figure 2. The upper ports can be opened by dropping a second ball and applying pressure.

# Clutch-Type, MULTI-FUNCTION CIRCULATING TOOL (MFCT)

## Specialized Tools: Circulating Tools

Efficient drilling is dependent on keeping the hole free of debris. The clutch-type MULTI-FUNCTION CIRCULATING TOOL\* (MFCT), developed for use when well cleanout is required prior to running completions or test strings, is a valuable option.

### Applications

The MFCT tool from M-I SWACO is particularly suited to wells with small

liner diameters where well cleanups are performed prior to running completions or test strings. This tool can be run when drilling cement and milling/polishing liner-top Polished-Bore Receptacles (PBRs), providing pipe rotation above the liner with the ports open while protecting the string below from potentially damaging torque.

### Features

- Does not require darts or balls to be pumped down the drill pipe
- Can be operated in the hole as many times as required by slacking off or picking up the drill pipe
- Allows drilling or milling to take place with the tool in the string
- Internal clutch allows drillstring rotation above the tool with the circulating ports open
- Available to run in all common casing and liner sizes

### Advantages

- Offers the option of performing the open/closed cycle as many times as required without having to pull out of hole, allowing immediate control of the circulation route
- More accurate fluid placement than can be obtained with a conventional ball drop circulation sub
- Only transmits rotating torque above the circulating ports, protecting the lower string from potentially damaging torque
- Increases flow rate in the annular sections

### How it works

The MFCT unit is operated in a similar fashion to a bumper sub used during drilling. The tool, made up with a shear ring in place (7,000 to 60,000 lb [3,175 to 27,216 kg] shear), is fully stroked out when running in hole, and circulation passes through the end of the drillstring. Rotating torque is transmitted to the whole string (clutch engaged). Upon first activation, the required weight is slacked off onto a device, such as a stabilizer or top-dress mill, at the point of interest (usually above a small-diameter liner) and the outer sleeve moves down, allowing the fluid bypass to be activated.

The tool is now open and high circulation rates can be attained through the tool ports. Rotating torque is only transmitted above the circulating ports (clutch disengaged). Circulation is restored through the end of the drillstring by simply picking up the drill pipe, moving the outer sleeve up and re-engaging the clutch. The open-closed cycle can be performed as many times as required without the need for expensive trips out of the hole, giving the driller immediate, positive control of the circulation route.



# PORTED BYPASS SUB (PBS)

## Specialized Tools: Circulating Tools

The PORTED BYPASS SUB (PBS) tool helps to establish communication between the fluids in the drill-pipe pressure and fluid flow around a tool in the drillstring.

### Applications

The PORTED BYPASS SUB tool from M-I SWACO is normally run above the WELL PATROLLER\* tool to provide an additional means of equalizing pressure and fluid flow around the tool, should it fill with debris while pulling out of hole. The WELL PATROLLER unit is run as a contingency device, and is only opened if required.

The PORTED BYPASS SUB tool can also function as a drill-pipe drain sub.

### How it works

The tool is run in the closed position, and when required, a ball is dropped to open the ports. Fluid can then be pumped both through the ports and down through the tool.

The PORTED BYPASS SUB unit is open communication between the drill pipe and the annulus.

### Features

- One-piece, full-strength drill-pipe mandrel
- Ball retained on seat in tool

### Advantages

- To open up communication between the internal diameter of the drill pipe and the annulus

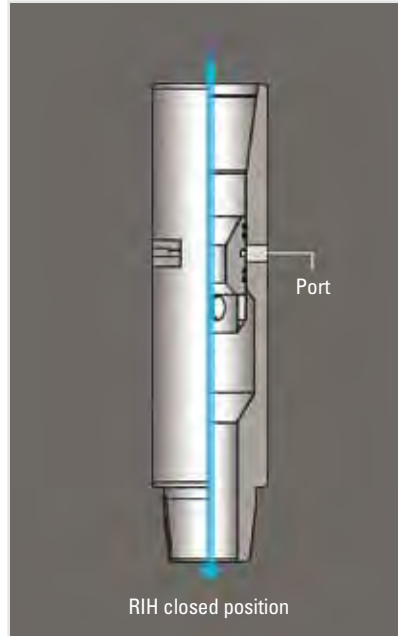

Figure 1. The PORTED BYPASS SUB is run in the hole in the closed position.

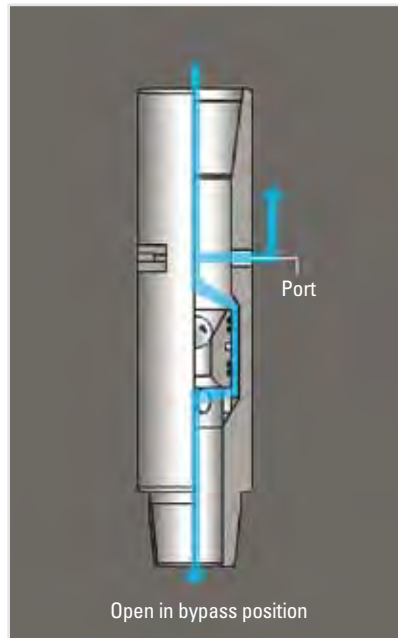

Figure 2. When pulled out of the hole, the tool is in the open position.



# SINGLE-ACTION BYPASS SUB (SABS)

## Specialized Tools: Circulating Tools

This tool makes it possible to boost the flow velocity in a casing string above a liner or casing crossover where a smaller liner exists.

### Applications

The SINGLE-ACTION BYPASS SUB (SABS) unit from M-I SWACO is used: to boost the flow velocity in a casing string above a liner or casing crossover where a smaller liner exists; to spot lost-circulation material or other pills, bypassing the motor or measurement-while-drilling tool; to boost flow in the annulus to remove cuttings beds; or to jet wellhead, blowout preventers or risers.

### How it works

Initially, the tool is run in hole with its ports in the closed position. To open the ports, a ball is dropped, and the pump rate is increased to circulate at higher annular velocity through the ports in the tool. To close the ports, a second ball is dropped, and pumping can be resumed through the string below the sub. Once dropped, both balls remain on seat at all times.

To have the option of reopening and then re-closing ports after the initial cycle, two SABS units can be run in tandem.

The SABS tool is used to boost flow velocity in a casing string above a liner or casing crossover.

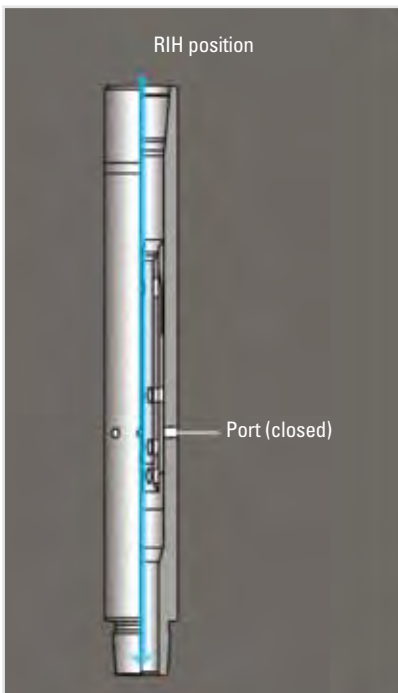

Figure 1. When desirable during the wellbore cleanup, a ball is dropped to a ball seat and pressure applied to open up the ports.

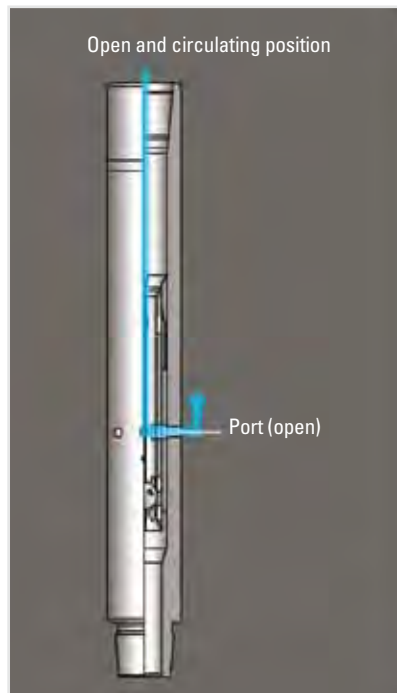

Figure 2. The pump rate can then be increased to circulate at increased annular velocity through the ports in the tool.



### Features

- One-piece, full-strength mandrel
- Balls retained on seats in tool

### Advantages

- When using the SABS tool to jet the riser, wellhead and/or BOP stack, the large, 11 to 16 in. (279 to 406 mm) OD sleeves allow the jets to clean closer to the profile
- To reopen and close ports after the initial cycle, two SABS units can be run in tandem

# WELL COMMANDER

## Specialized Tools: Circulating Tools



The WELL COMMANDER\* tool is a ball activated circulating valve that can be placed above sensitive bottomhole equipment such as MWD and LWD tools, core barrels and mud motors. It provides an alternate circulation path for performing numerous critical functions and mitigating drilling hazards. The WELL COMMANDER tool mitigates the problems encountered with a restrictive BHA that limits the flow rate and annular velocity. These BHA restrictions also limit the size and concentration of the loss circulation or wellbore strengthening material needed for lost-circulation zones. The WELL COMMANDER tool provides a large, flow-area bypass on demand through as many as nine open-and-close cycles in one trip.

### Applications

The innovative WELL COMMANDER tool is used in the I-BOSS\* wellbore strengthening technology to provide an alternate path for placing the WSM in troublesome zones. The tool allows placement without having to pass the material through size- and concentration-restricted BHAs.

Placing the WELL COMMANDER tool above an under-reamer or similar ball-drop tool can be highly advantageous. The WELL COMMANDER tool permits increasing annular velocities during drilling operations by bypassing BHA components. In addition it can be used to enhance annular velocities during displacements. Typically, this capability prevents or removes cuttings-bed buildup, enhances fluid displacement and simplifies reverse circulation.

The tool can be used as a fill or drain valve while tripping the drill string to control surge and swab pressures.

The WELL COMMANDER valve can also be used to place kill weight fluid in underbalanced or managed pressure drilling operations.



## Features

- The tool has a generous flow through area via multiple ports
- The BYPASS BALL CATCHER\* unit has an 18 ball capacity which allows up to 9 complete open/close cycles
- The same size ball opens and closes the ports
- The tool is available in 5 in., 7 in., 8¼ in. and 9½ in. OD, for all drillstring configurations
- There are no internal tool connections
- The tool activation mechanism locks into the open or closed position and is isolated from the circulating fluids
- The WELL COMMANDER tool and BYPASS BALL CATCHER tool permits smaller ball and/or limited wireline access below the WELL COMMANDER unit even after it has been activated
- The WELL COMMANDER tool saves valuable rig time by reducing trips/circulating time

## Advantages

- Due to the large flow area, pump rates can be boosted significantly increasing annular velocities to aid in cuttings-beds removal
- Coarse lost-circulation or wellbore-strengthening materials can bypass sensitive downhole drilling tools and be easily placed in the loss zone
- Kill-weight fluid can be pumped in underbalanced or managed-pressure drilling applications before initiating a trip
- The tool is excellent for hole cleaning enhancement during underreaming, hole-opening, or coring operations
- The tool can condition fluid at high flow rates in any drilling or displacement workstring
- The WELL COMMANDER tool helps fill or drain the drillstring during trips to control surge and swab pressures and to enhance tripping operations by minimizing fluid discharge
- When the tool is in the locked open position a small percentage of fluid will still flow through the bit, keeping it lubricated. If the optional shut-off ball is utilized, 100% of the flow is through the ports



The WELL COMMANDER tool uses the same size operating ball to open and close the ports



Open circulating ports provide generous flow area

## How it works

The WELL COMMANDER tool is run in or pulled out of the hole with the ports locked open or closed. The WELL COMMANDER valve remains in the same position until activated by dropping a ball and pressuring up to shift the the tool open or closed. The activation ball is then captured in the side pocket of the ball catcher. The tool uses the same size activation ball to open and close the ports, with the capacity of the ball catcher (18 balls/ 9 cycles) the only limit. With the tool in the open position a smaller optional BHA

shut-off ball can be dropped which will seat on the lower ball seat and direct 100% flow out of the ports. This ball is then expelled with the subsequent activation ball, which also cycles the tool to the closed position. Both balls are then captured by the ball catcher.

The bypass ball catcher captures the balls to one side of the inside diameter to facilitate positioning other ball-drop tools below it, as smaller activation balls can pass through the WELL COMMANDER tool and ball catcher.





1. Ball landing

Drop ball on connection and pump down to tool. Ball lands on seat. Pressure is applied



2. Valve activation

When pressure exceeds activation pressure, ports open and ball proceeds to ball catcher below tool

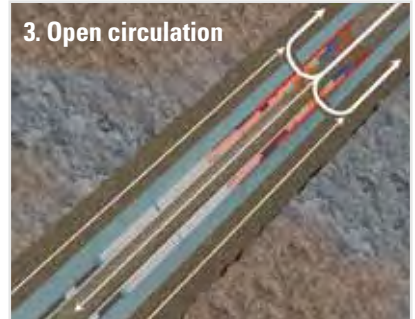

3. Open circulation

Majority of flow passes through the ports with lower pressure to allow increased pump rates, while some flow is maintained through the bit for lubrication



4. BHA shut off

Optional shut-off ball can be landed on lower ball seat to prevent LCM or WSM from entering the BHA while treating the formation



5. Valve closing

The BHA shut-off ball is removed when subsequent activation ball closes the ports



6. BHA shut off removal

After pressuring up on the activation ball, the BHA shut-off and activation balls move to the ball catcher

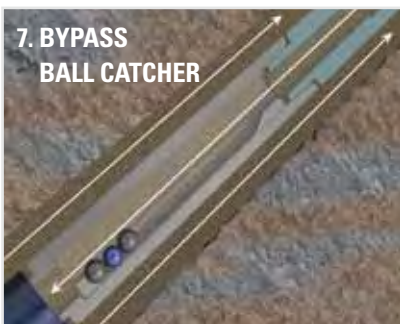

7. BYPASS BALL CATCHER

BYPASS BALL CATCHER tool captures activation and BHA shut-off balls to the side permitting high flow rate with minimal pressure loss and allowing smaller balls to pass through it



8. Other activation balls

Other ball activation tools that use smaller diameter balls can be positioned below the WELL COMMANDER tool as the ball will not activate it

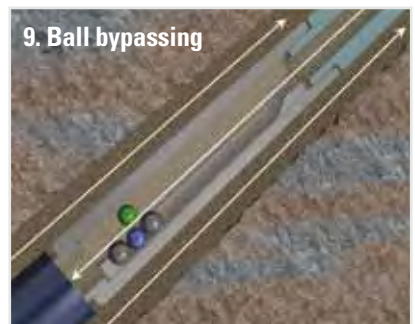

9. Ball bypassing

The activation balls for these other tools will pass through the BYPASS BALL CATCHER unit



# WELL ISOLATION TOOL (WIT)

## Specialized Tools: Circulating Tools

The WELL ISOLATION TOOL\* (WIT) is a circulating tool with annular-isolation capabilities, allowing the operator to isolate the wellbore from hydrostatic and induced pressures and still circulate at increased rates. This is often necessary to control fluid loss to open perforations or an open hole interval below the tool.

### Applications

The WELL ISOLATION TOOL can accommodate high circulation rates to displace the upper part of a well without applying pressure to the lower part. It is most effective where there is no set-down point, such as a liner top for conventional weight-activated circulating tools. It is ideal where fluid loss to perforations or open hole sections would be expected below the tool, and it can be run above pressure-sensitive equipment, such as fluid-isolation valves.

### Features

- Ball-drop activation and deactivation
- Two internal ball seats move to activate and deactivate the tool
- Balls retained on seats in tool
- Stabilizer and stabilizer-mill profiles ensure there are no casing restrictions and protect the diverter cup from possible damage
- Available in 7 in., 9 5/8 in. or 10 3/4 in. sizes
- No limit on rotation speed while circulating

### How it works

The tool is run in the hole in the open position, with full flow to the bit. In this configuration the internal bypass is open so the annular fluid can bypass the annular diverter cup. In operation, the activation ball is dropped to a ball seat, and applied pressure shears the shear screws, moving the activation sleeve. This closes the diverter-cup bypass. In this position, all flow through the string is directed out through the WIT unit ports above the diverter cup to the upper annulus. The tool isolates the open perforations or open-hole section below the full gauge diverter cup from the circulating fluid. To reverse the procedure, the deactivation ball is dropped and pressure is applied to shear another set of screws and move the activation sleeve to reopen the bypass and reestablish circulation to the bit. The WIT device then can be tripped out of the hole without swabbing the well.

### Advantages

- Boosts annular velocity while protecting the formation or open perforations from excessive surge/ECD pressures
- Built-in bypass channel around the annular-isolation diverter cup prevents surging or swabbing the well during trips
- Prevents losses under static as well as dynamic conditions



# JUNK MUNCHER (JM)

## Specialized Tools: Debris Recovery Tools

The JUNK MUNCHER tool from M-I SWACO is used to validate wellbore cleanup operations. It collects larger pieces of milling debris generated during casing milling or window-cutting operations. It can also clean up perforation debris that restricts the ID of perforated pipe.

### Advantages

The JUNK MUNCHER tool is suitable to run after casing-milling or window-cutting operations to collect larger pieces of milling debris sometimes produced during these operations and which cannot otherwise be removed. It is also suitable for use in already perforated pipe to clean up or remove perforation debris that restricts the ID while retrieving junk that cannot be circulated out.

The milling profile can be supplied suitable to dress off liner-top Polished-Bore Receptacle (PBR) profiles. The bypass and swallowing capacity have been maximized by using a smaller, high-torque, rotary-shouldered connection on the bottom of the tool.

### Features

- One-piece mandrel with box-up/pin-down connections
- Integral liner-top dress-mill profile or junk-mill profile available
- Pilot mill available

### Advantages

- Designed to remove large pieces of debris from the wellbore through large entry throats
- Run as part of the cleanup operation or as part of a dedicated junk cleanout run
- When run below the WELL PATROLLER\* device, the tool allows smaller debris to pass through to be collected by the WELL PATROLLER tool

### Operation

The JUNK MUNCHER unit can be run in a combination drillstring to collect junk in larger casing above a liner, or directly above a mill or bit to collect large pieces of junk off the bottom. The bit or mill acts to jet and circulate the junk up into the catcher.

When the integral liner-top dress mill lands out on the PBR it can be used to dress off the PBR top. If required, a tieback mill can be run below the tool to clean the PBR ID. The JUNK MUNCHER tool is run with a maximum running-in-hole/pulling-out-of-hole speed of 150 ft/min (46 m/min), which means that there are no restrictions compared to others in the string.

### How it works

The collection vessel is a large-OD tube ported to allow debris, cuttings, cement particles and smaller pieces of junk to pass through and be circulated out of the hole. The large pieces of junk that enter the collector are retained and prevented from falling out the bottom by flapper valves that are flow-assisted to open and spring-assisted to close.

A significant volume of large junk pieces can be collected in the tool. In the case of extremely large pieces of junk, drilling/milling services can be provided to assist in reducing the size of the junk.



The JUNK MUNCHER tool can be run on the same trip as a precompletion mechanical wellbore cleanup run or during a dedicated junk cleanout run.



### Operating parameters

Box connection size, in.	Maximum rotating speed in tension, rpm	Maximum rotating speed in compression, rpm	Maximum compression at tool when rotating, lb (kg)
3½ IF	100	60	5,000 (2,268)
4½ IF	120	90	10,000 (4,536)
5½ NK DSTJ	120	90	10,000 (4,536)

These are general guidelines only and are subject to review, if required, for individual circumstances.

# MAGNOSHOE (MSHOE)

## Specialized Tools: Debris Recovery Tools

The MAGNOSHOE\* (MSHOE) magnet is designed to retrieve irregular shaped debris that has fallen to the bottom of the wellbore and cannot be circulated back into the annular path of a traditional drillstring magnet. Designed with the best technology available in magnets, the tool simplifies and enhances any wellbore preparation operation.

### Applications

The MAGNOSHOE tool can be used in any situation where large metallic debris is sitting on the bottom of the wellbore or on top of another element in the wellbore. Since large debris can be difficult to mill and circulate back into the fluid stream, the debris must be retrieved mechanically. The tool is used in any wellbore preparation activity such as displacement or dedicated fishing or cleanout trip. It is deployed quickly on the end of the workstring.

### Features

- Fully encased rare earth magnet
- Magnet components rated to 480°F (250°C)
- Forward facing circulation ports
- Simple three piece construction
- Modular protective shroud

### How it works

The MAGNOSHOE tool is run in the well on the end of the workstring. The tool employs a protective coating of gel to prevent the accumulation of debris on the way into the hole. The target debris will yield the gel on contact so that the target comes into direct contact with the magnetic forces. The target debris is then held connected to the magnet until it is physically removed on surface. When the tool and the debris are brought out of the hole, the MAGNOSHOE tool can be quickly removed from the string and set aside to prepare for the next operation.

### Advantages

- High strength magnet array can carry and retain oddly shaped debris
- Magnet components rated to 480°F (250°C)
- Captured debris is not disturbed by fluid draining from drill string
- Protective shroud can be changed out on the rig to increase capture space for the varying amount, size and shape of debris
- Easily cleaned on rig for subsequent runs



# MAGNOSTAR (MSTAR)

## Specialized Tools: Debris Recovery Tools

The MAGNOSTAR\* (MSTAR) magnet was designed specifically for large-volume cleanup applications in high torque strings. The MAGNOSTAR magnet provides superior magnetic surface area for high volume ferrous debris extraction when circulation alone is insufficient.

### Applications

The MAGNOSTAR tool is well-suited for a variety of applications, including displacements, post-perforating, pre-fracturing, multi-zone completions, milling, burning, fishing and smart completions. The tool should be run whenever the potential exists for significant ferrous debris in the wellbore.

### Features

- Single Piece Mandrel, no internal connections
- Optional Dedicated Flow Path to prevent flow path restrictions when packed full of debris
- Fixed Stabilizer Sleeve on box end to provide standoff when POOH
- Casing compatible facing material to minimize casing wear
- Unique, patent pending mechanical method of retaining magnets
- Available in common casing/liner sizes and weights (13 $\frac{3}{8}$  in. to 7 in.)

### How it works

The MAGNOSTAR magnet is run in the well on the workstring in combination with other wellbore clean-up tools. The magnet can be rotated and reciprocated without fear of damage to the casing or the tool itself. The blades on the housing provide generous flow area for fluid bypass around the tool. The fixed stabilizer sleeve on the box end provides stand-off and a secure area away from the casing wall to collect debris while pulling out of the hole. It is available in common casing/liner sizes and weights.

### Advantages

- Potential capacity for up to 200 lb (91 kgs) of ferrous material retrieval
- High strength, rare earth magnets rated to 350°F (177°C)
- Removable magnets for body inspection
- Designed with premium high torque connections
- No flow restriction below the tool permitting large debris-free access to magnets
- Recovered debris easily removed on location



# MAGNOSTAR Heavy Duty (MSTAR-HD)

## Specialized Tools: Debris Recovery Tools

The MAGNOSTAR\* HD (MSTAR-HD) magnet was designed specifically for large-volume cleanup applications in high torque strings. The MAGNOSTAR magnet provides superior magnetic surface area for high volume ferrous debris extraction when circulation alone is insufficient. The MAGNOSTAR HD tool version is fitted with mill rings on the box and pin connections for more aggressive applications.

### Applications

The MAGNOSTAR HD tool is well-suited for a variety of applications, including displacements, post-perforating, pre-fracturing, multi-zone completions, milling, burning, fishing and smart completions. The tool should be run whenever the potential exists for significant ferrous debris in the wellbore.

### Features

- Single Piece Mandrel, no internal connections
- Optional Dedicated Flow Path to prevent flow path restrictions when packed full of debris
- Fixed Stabilizer Sleeve on box end to provide standoff when POOH
- Casing compatible facing material to minimize casing wear
- Unique mechanical method of retaining magnets
- Upper and lower mill rings
- Available in common casing/liner sizes and weights (13<sup>3</sup>/<sub>8</sub> in. to 7 in.)

### How it works

The MAGNOSTAR HD magnet is run in the well on the workstring in combination with other wellbore clean-up tools. The magnet can be rotated and reciprocated without fear of damage to the casing or the tool itself. The blades on the housing provide generous flow area for fluid bypass around the tool. The fixed stabilizer sleeve on the box end provides stand-off and a secure area away from the casing wall to collect debris while pulling out of the hole. The mill rings allow the tool to grind down larger pieces of debris either below or above the magnet. It is available in common casing/liner sizes and weights.

### Advantages

- Potential capacity for up to 200 lb (91 kg) of ferrous material retrieval
- High strength, rare earth magnets rated to 350°F (177°C)
- Removable magnets for body inspection
- Designed with premium high torque connections
- No flow restriction below the tool permitting large debris-free access to magnets
- Recovered debris easily removed on location
- Larger pieces of debris can be ground down with the mill rings



# MAGNOSWEEP II (MSWEEP II)

## Specialized Tools: Debris Recovery Tools

The MAGNOSWEEP\* II (MSWEEP II) magnet is designed to recover large volumes of ferrous debris to ensure the integrity of the wellbore cleanup. The magnet features a large magnetic surface area along with discrete flow channels to combine higher magnet strength with greater volume to optimize recovery. The tool can be run as a component of most drilling/milling/polishing assemblies or as an integral part of the drillstring during wellbore preparation operations.

### Applications

The MAGNOSWEEP II magnet is run as an integral part of the work string during cleanup to collect and remove ferrous debris. It also can be run as a part of a cased hole drilling assembly, including milling or polishing assemblies. The MAGNOSWEEP II magnet should

be run in any operation with the potential of generating or encountering ferrous debris. This could include displacements, perforating, pre-fracturing, milling, burning, fishing, and multizone or smart completions. The tool can be rotated and reciprocated without fear of damaging the casing or other tools.

### How it works

The MAGNOSWEEP II magnet is made up in the workstring as a conventional tool. It has no limiting trip-speed factor and can be rotated at common drilling speeds. The blades on the housing provide generous flow area for fluid bypass around the tool while at the same time the stabilizers provide stand-off for a secure area away from the casing wall to collect debris.

### Features

- Compact design
- Single piece mandrel
- High strength rare earth magnets
- Fixed stabilizer sleeve to provide stand off when POOH
- Optional dedicated flow channel to prevent flow path restrictions when packed full of debris

### Advantages

- Removable magnets for body inspection
- Recovered material is easily removed on location
- High temperature rating on magnets up to 350°F (177°C)
- Debris channels allow for larger volume of ferrous material to accumulate



# SWITCHBACK MAGNET (SWBM)

## Specialized Tools: Debris Recovery Tools

The SWITCHBACK\* MAGNET (SWBM) tool can be run in the hole in the dormant position as an integral part of a drilling or milling BHA. The tool's magnets are activated when desired via a ball drop mechanism, at which time they will collect ferrous debris from the wellbore. As such, the magnet only collects metallic debris at the zone of interest, such as in a milled window and above. Material is not collected while tripping in or during the milling or drilling operation as a conventional magnet would.

### Applications

The SWITCHBACK MAGNET tool can be used during any operation where ferrous debris is expected in the wellbore. This can include milling casing exits, downhole equipment such as packers, tubing, or other debris left in a well, sidetracks or conventional drilling operations.

### How it works

The SWITCHBACK MAGNET tool is included in the drilling or milling workstring. The tool is run in the well in

dormant mode, with the magnets inactive (turned off). When drilling/ milling operations cease at interval total depth, a ball is dropped to the tool. If more than one SWITCHBACK MAGNET tool is run in the workstring, this ball will activate all the tools simultaneously. Once the ball lands on seat, pressure is applied to the recommended amount to function the tool and allow the magnet to activate. If more than one SWITCHBACK MAGNET tool is run on the same workstring, the process of pressuring up is repeated until all of the tools are activated. At that point, the ball is caught in a BYPASS BALL CATCHER\* tool below the lowest SWITCHBACK MAGNET tool. Once functioned, the SWITCHBACK MAGNET tool is tripped out of the well collecting ferrous debris along the way. On surface, the tool is moved away from the rotary table to remove the debris and clean the tool. The reset button is pressed to deactivate the magnet and release captured debris. The SWITCHBACK MAGNET unit is then ready to rerun into the well when desired.

### Features

- Tool is activated downhole by dropping a ball, through patented ball seat technology
- One-piece body; no internal connections
- Free rotating stabilizer sleeves independent of drill string rotation
- Reset button functionality to switch tool off once on surface
- BYPASS BALL CATCHER tool run below the tool to capture expelled ball(s)
- BYPASS BALL CATCHER tool retains operating balls yet allows smaller balls to pass enabling numerous ball activated tools to be utilized in the same string

### Advantages

- Ferrous debris collected from the bottom to top of the well and not while running in the hole
- Stabilizer sleeves will not rotate when drill string is rotating, minimizing casing wear
- Several SWITCHBACK MAGNET tools can be run in series or with a SWITCHBACK Scraper or SWITCHBACK Mill, with the same ball activating all tools
- Mill rings break up large pieces of debris to circulate past the tool
- SWITCHBACK MAGNET tools generate a very low magnetic field and will not interfere with the MWD system signal



# WELL PATROLLER

## Specialized Tools: Debris Recovery Tools

The WELL PATROLLER\* downhole filter tool is an advanced M-I SWACO wellbore preparation tool developed for use in precompletion/displacement operations, where a high degree of cleanliness and validation thereof is required.

### Applications

The WELL PATROLLER tool is designed to be run in the displacement workstring. It completes the displacement operation by filtering the completion fluid in the wellbore while pulling out of the hole and as a result validates well cleanliness. It

should be run in the well with other wellbore preparation tools like the BRISTLE BACK\* brush, RAZOR BACK\* scraper and MAGNOSTAR\*, as well as circulating tools like the WELL COMMANDER\* or MULTI-FUNCTION CIRCULATING TOOL\* (MFCT). The WELL PATROLLER tool can also be used in the blow out preventer jetting string. When used in the wellhead cleaning string, the WELL PATROLLER tool is placed in the casing below the wellhead to capture debris jetted from the blow out preventer cavities.

### Operating parameters

Tool (casing) size, in.	Maximum rotating speed in tension, rpm	Maximum rotating speed in compression, rpm	Maximum compression at tool when rotating, lb (kg)
4½ – 5½	90	60	5,000 (2,268)
6½ – 8½	100	60	10,000 (4,536)
9½ – 13½	120	90	15,000 (6,804)

These are general guidelines only and are subject to review, if required, for individual circumstances.



Specialized Tools: Debris Recovery Tools: WELL PATROLLER



### How it works

As the workstring is run in the whole, the diverter/wiper cup cleans the inside diameter of the casing and forces all the wellbore fluid to pass through the WELL PATROLLER tool from the bottom.

(Fig. 1) After running in the hole, the displacement is carried out in the usual manner with the fluid in the annulus passing between the mandrel and filter screen. When circulation is complete and the workstring is pulled out of the well, the diverter/wiper cup cleans the inside diameter of the casing and directs all fluid into the filter screen section. As the kidney valves are now closed, all the fluid is filtered through the screen and any debris remaining in the wellbore is now captured inside the filter screen.

(Fig. 2) If the well was displaced properly, there should be very little material captured in the WELL PATROLLER tool, thereby validating the casing is thoroughly cleaned and ready for the next completion operation.

The WELL PATROLLER unit should not be placed where it passes through drilled out casing accessories like landing or float collars. It should be placed at least 30 ft (9 m) above the bit or mill. It can be run in or pulled out at speeds up to 150 ft/m (46m/min). It is possible to reverse circulate through the WELL PATROLLER tool, but it is recommended to circulate at least one hole volume conventionally before reverse circulating.

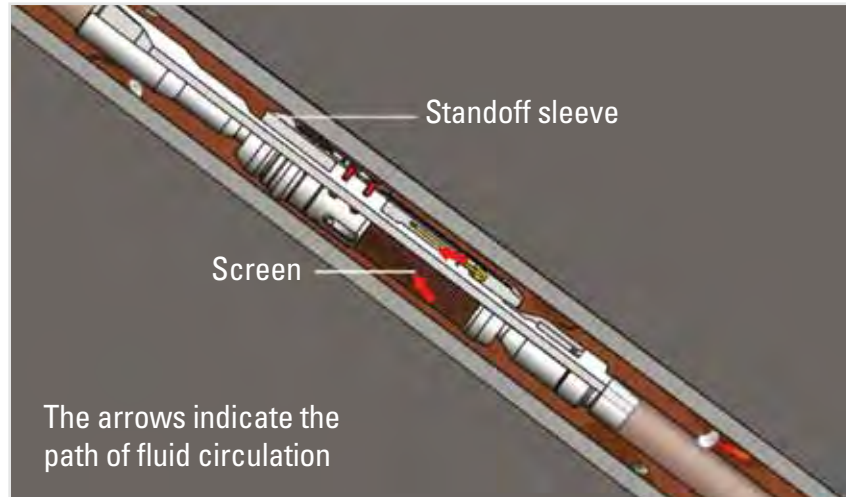

Figure 1. Running in hole, wiping the ID of the casing.

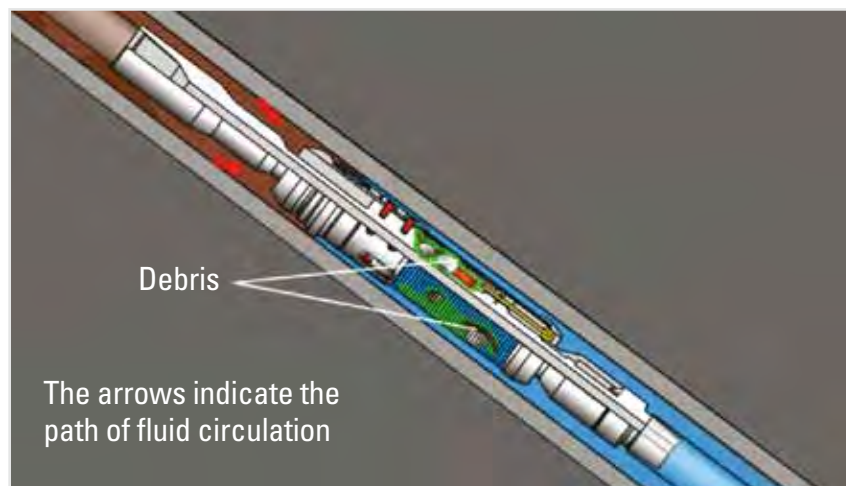

Figure 2. Pulling out of the hole, collecting residual debris.

### Features

- Available in all common casing and liner sizes
- No balls or darts required for activation
- 600 micron screen to effectively filter debris
- Kidney shaped valves allow large debris pieces to be captured in the tool
- Large flow area through tool
- Field redressable
- Rupture disc relieves pressure if filter is plugged or filled

### Advantages

- No balls or darts pumped down the workstring
- Tool operated during basic tripping operations in and out of the well
- Can drill or mill with WELL PATROLLER tool in the workstring
- Tool cleans wellbore and then validates cleanliness of the wellbore
- Multiple tools can be used in a single string

# WELL PATROLLER 500 Series

## Specialized Tools: Debris Recovery Tools

The WELL PATROLLER\* 500 Series downhole filter tool is an advanced M-I SWACO wellbore cleanup tool developed for use in the precompletion/drill-stem test phase of a well, where a high degree of cleanliness and validation of such is required. The 500 Series tool uses a secure flapper valve assembly and a more robust filter assembly than previous models of the WELL PATROLLER validation tools.

### Applications

The tool is designed to be run in the cleanup string and completes the cleanup by filtering the remaining debris from the annulus through a wire screen filter. It is usually run in conjunction with the MFCT, RAZOR BACK\* and BRISTLE BACK\* tools, or other wellbore preparation tools. In this application the WELL PATROLLER 500 Series tool validates that the well is clean post displacement.

One other application is that the tool is often positioned in the casing below the wellhead during riser cleaning and

blowout preventer wellhead jetting to collect any dislodged debris that falls into the well.

### How it works

As the string is run in the hole, the diverter cup/wiper cleans the ID of the casing, removing the film of gunk (oil-base mud, barite, cement and magnetized steel particles) clinging to it. The displacement operation is carried out in the normal way, pumping down through the WELL PATROLLER 500 Series drill-pipe mandrel and back up between the mandrel and the filter jacket. When circulation is complete, the string is pulled and the diverter cup/wiper cleans the ID of the casing and diverts the annular fluid through the tool. The fluid passes through the wire screen filter with debris being retained inside the tool screen body. Performing a dual function, the WELL PATROLLER 500 Series tool first performs a cleaning action and then validates the effectiveness of the cleanup operation.

### Features

- Available in all common casing and liner sizes
- No balls/darts for activation
- Increased mandrel strength
- 0.025 in. (0.6 mm) screen to filter out small particles
- Flapper valves allow larger pieces of debris to pass into tool
- All fasteners are internal
- 12.72 gallon debris capacity
- Large flow areas through the tool even though diverter cup is in contact with casing ID
- Field redressable
- Rupture discs relieve pressure in the unlikely event that the tool becomes completely full of impermeable material

### Advantages

- The tool is operated simply by running in hole and pulling out of hole
- Allows milling or drilling to take place with tool in the string
- Avoids surge and swab pressures
- Dual functionality tool, first performs a cleaning action, then validates the effectiveness of the cleanup operation
- Tandem and triple runs possible



# WELL PROTECTOR

## Specialized Tools: Debris Recovery Tools

Thorough cleaning of the wellhead and Blowout Preventer (BOP) areas of any surface well must include catching the harmful debris loosened by the operation.

### Applications

The WELL PROTECTOR\* tool from M-I SWACO captures material loosened during cleaning of the BOP and wellhead and/or operational testing of the BOP rams. It acts as a backup to catch debris that is not circulated out or that falls downward into the well.

### How it works

The tool is run below the wellhead inside the casing during BOP and wellhead jetting or functioning of the BOP rams. It can be positioned in the casing during riser cleaning operations or when retrieving wear bushings/bore protectors.

The tool features a large-capacity, 6 ft (2 m) wire-wrap screen to filter out small and large debris that falls into it. A rounded bullnose on the bottom acts as a guide and is equipped with a large valve for easy removal of collected material. Above the filter screen is a diverter cup and ported standoff guide to ensure that all the debris is collected rather than falling around the outside of the tool.

The WELL PROTECTOR tool is equipped with an integral drill-pipe-handling sub for slips and elevators and a 4½ in. (114 mm) IF (NC 50) box connection.

### Features

- Large debris/junk collection capacity
- 0.025 in. (0.635 mm) screen filters out small particles
- Diverter cup prevents bypass of debris
- Integral drill-pipe handling sub
- Can be redressed in the field

### Advantages

- Available for all common casing sizes located directly below the wellhead
- Simple to run and redress and can be used multiple times without the need for onshore service and inspection



# WELL SCAVENGER (WS)

## Specialized Tools: Debris Recovery Tools

The WELL SCAVENGER\* vacuum debris removal tool is designed specifically to capture and remove debris from the wellbore. The tool can be combined with magnets or junk baskets to enhance removal of ferrous or larger debris, respectively. The tool engine module generates a high velocity reverse circulation path at the end of the workstring to pick up heavier debris and capture it in-situ. The modular designed WELL SCAVENGER tool comprises a single nozzle jet pump; a screen filter with an internal magnet assembly; debris chambers with a suction tube and flow deflector.

### Applications

The WELL SCAVENGER tool is used during intervention applications requiring in-place debris removal. It can be run to remove debris from top of isolation valves, blanking plug removal, and cleaning out after perforating.

The tool also can be run during milling operations to capture debris as it is generated, or during fishing operations to remove unknown debris. The tool can be used effectively in clear brine completion fluids with no carrying capacity or suspension characteristics. The WELL SCAVENGER tool can also be used where low circulation rates are desired, such as near sensitive downhole hardware or where perforations are open.

### How it works

The WELL SCAVENGER tool pumps the “driving” fluid through the fluid jet pump, thus generating a reverse circulation flow from the bottom of the tool through the suction tube. Once the debris is picked up, it settles in the debris basket as the fluid velocity decreases after passing through the flow diverter. The fluid then passes through the filter screen to capture suspended material.

### Features

- Circulation rate of the driving fluid is 200-350 gpm (750-1,325 L/min)
- Suction fluid is usually 25-30% of the driving fluid flow
- The WELL SCAVENGER tool incorporates an internal magnet assembly
- Debris chamber capacity is 0.5 bbls
- Designed for small amounts of debris recovery on or near sensitive equipment such as plugs and Formation Isolation Valves (FIVs)

### Advantages

- Generates a reversing flow path that promotes in-situ debris collection
- Operates with 125 ft (38 m) of tail pipe to allow removing debris on top of packers and formation isolation assemblies
- Creates various “reverse” flow rates
- Removes heavy/difficult debris from wellbore with minimal circulation
- Efficiently collects magnetic debris
- Safe and well-organized debris collection that is 100% contained and allows all fluid to be drained in a safe controlled manner
- Minimize risk of debris plugging filter screen with internal magnet assembly



# PUP RISER BRUSH (PRB)

## Specialized Tools: Riser Cleaning Tools

### Applications

The PUP\* RISER BRUSH (PRB) tool utilizes three aggressive stainless steel brush rings to remove debris from the marine riser or outer production riser ID. The design of the tool provides a flow path through the brush-ring carrier, with the majority of the flow passing through 65 in.<sup>2</sup> (41,935 mm<sup>2</sup>) of flow area in the brush carrier, minimizing pressure drops above and below the tool.

### Tool Use

The PUP RISER BRUSH tool mechanically cleans marine risers and outer production risers.

### Features and Advantages

- Safety feature: The tool design incorporates an integral pup joint to facilitate tool pickup with standard drill-pipe elevators and slips
- Aggressive, non-rotating stainless steel brushes (synthetic brushes available)
- Workstring can be rotated and reciprocated with the PUP RISER BRUSH tool in the workstring
- Debris can be effectively circulated through and around the tool
- The large mandrel ID enhances circulation
  - Available in 13¾ through 24 in. OD
  - Large flow-through area reduces the probability of swabbing/surging in the hole or pulling out of the hole
  - Eliminates the need for a junk basket tool above the RISER BRUSH
  - Can be run as a standalone tool, and it is typically run in conjunction with the PUP QUICK-TRIP BOOT BASKET or PUP FINGER BASKET to protect the well from debris re-entering the wellbore while jetting the BOP



# RISER CLEANING TOOL (RCT)

## Specialized Tools: Riser Cleaning Tools

The RISER CLEANING TOOL (RCT) is designed to simultaneously brush, wipe and collect any debris that may be present in the riser, with the added capability of passing through a constrictive wellhead ID. The tool is also equipped with an integral junk bucket to enable any loosened debris to be captured.

### Applications

The RISER CLEANING TOOL is used prior to any completion operation requiring a clean riser or when displacing drilling fluid from the riser. The tool ensures removal of the sheath of debris-laden fluids from the riser wall and

prevents the remaining fluid sheath from depositing solids on sensitive completion string components, thus helping eliminate expensive and time consuming non-productive time (NPT).

### How it works

The RISER CLEANING TOOL is designed to pass through ID restrictions, yet still provide aggressive mechanical scratching and wiping to remove even the most stubborn fluid sheaths. The debris is extracted from the riser with the associated integral Junk Bucket.

### Features

- Mandrel designed to support full casing string
- Long, stiff brush bristles to pass through smaller BOP restrictions, yet permit aggressive riser contact
- Integral junk bucket to capture debris

### Advantages

- Stops accumulated debris from interfering with completion operations
- Full 360° cleaning coverage
- Can be short-tripped during a pre- or post-clean up job
- Fits into any string where the riser is to be cleaned
- Designed for safe handling on the rig floor
- Permits running liner/casing during cleanup trip



# RISER DISPLACEMENT CLEANING TOOL (RDCT)

## Specialized Tools: Riser Cleaning Tools

The RISER DISPLACEMENT CLEANING TOOL\* (RDCT) is a cost-effective solution for displacing invert emulsion drilling fluids with seawater before quickly disconnecting the riser. The RDCT unit is set in the riser at the top of the BOP and pumped back to surface. It wipes the riser while pushing all debris to surface. It helps eliminate the environmental risks associated with disconnecting the riser while improving safety and simplifying the cleaning process by avoiding laying down an unclean riser.

### Applications

The RDCT tool is used prior to any completion operation requiring a clean riser or when displacing fluid from the riser prior to a disconnect operation. The tool protects expensive fluids from contamination or dilution with seawater. It provides assurance that not only is debris removed from the riser, but also the residual film of solids-laden invert fluid is cleaned from the riser wall.

This tool is especially beneficial during emergency disconnects when time is critical. The RDCT tool eliminates extra

pumping time to over-displace the riser to insure that the fluid interface is completely out of the riser before disconnecting. It also simplifies pit management concerns as fluids and interfaces will not need to be separated on surface. In addition, it is used when the riser is left open-ended during disconnect operations. It allows for easy displacement without risking the contamination of expensive drilling or completion fluids and any subsequent reconditioning of the fluids.

### How it works

The RDCT unit is deployed on a running tool and staged at the top of the BOP. It is released from the BOP and pumped to surface through choke and kill lines. It acts as a wiper to clean the riser wall. With different sized wipers to account for varying diameters in the riser system, the tool forms a positive seal that assures all surfaces are cleaned. It also acts as a mechanical barrier between fluids during displacement. It can be run by itself or in conjunction with a storm packer.

### Features

- Provides a mechanical barrier between two different fluids
- Uses specialized, simple running and retrieving tools
- The buoyant material provides a lightweight tool that quickly and efficiently arrives at surface
- Multiple size wipers clean varying ID of riser wall

### Advantages

- Less fluid loss to interface
- Cleaner riser and displacement
- No special pumping restrictions
- Does not increase disconnect time
- Eliminates mud residue on deck
- Eliminates riser cleaning on deck
- Minimizes fluid contamination



# DUAL-ACTION BYPASS SUB JETTING TOOL (DABS-JT)

## Specialized Tools: BOP Cleaning Tools

During drilling operations, debris such as drill cuttings and mud cake attach to riser, Blowout Preventer (BOP) and wellhead walls. Removing these contaminants is crucial to ensuring clean cementing and completion operations.

### Applications

The DUAL-ACTION BYPASS SUB JETTING TOOL (DABS-JT) from M-I SWACO is designed to run in a cleanup string for jetting the riser, BOPs and wellhead areas.

### Features

- One-piece, full strength mandrel
- Balls retained on seats in tool
- Available with 11 or 16 in. (279 or 406 mm) OD sleeve
- Sixteen 0.437 in. jet nozzles at 22° phasing

### How it works

The DABS JETTING TOOL is run in the open position for jetting and cleaning while traveling through the BOPs, wellhead and riser. The external jetting nozzles on the sub are then closed, by dropping an actuator ball, to allow flow through the sub and to circulate the string. By dropping another ball, they are reopened when pulling out, allowing jetting of the riser and BOPs. The balls remain on seat at all times.

### Advantages

- When using the DABS unit to jet the riser, wellhead or BOP stack, the large 11 or 16 in. (279 or 406 mm) OD sleeves allow the jets to clean closer to the profile





# SINGLE-ACTION BYPASS SUB JETTING TOOL (SABS-JT)

## Specialized Tools: BOP Cleaning Tools

During drilling operations, debris such as drill cuttings and mud cake attach to riser, Blowout Preventer (BOP) and wellhead walls. Removing these contaminants is crucial to ensuring clean cementing and completion operations.

### Applications

The SINGLE-ACTION BYPASS SUB JETTING TOOL (SABS-JT) from M-I SWACO is designed to run in a cleanup string for jetting the riser, BOPs and wellhead areas.

### Features

- One-piece, full-strength mandrel
- Balls retained on seats in tool
- Designed to boost annular velocity
- Available with 11 or 16 in. (279 or 406 mm) OD sleeve
- Sixteen 0.437 in. jet nozzles at 22° phasing

### How it works

The sub is run with the nozzles in the closed position. Dropping an actuator ball opens them so the pump rate can be increased to jet through the nozzles for cleaning. Dropping a second ball closes the nozzles to allow flow through the sub and to circulate the string. The balls remain on seat at all times but, when the nozzles are closed, pumping can be resumed through the string below.

### Advantages

- When using the SABS JETTING TOOL to clean the riser, wellhead or BOP stack, the large 11 or 16 in. (279 or 406 mm) OD sleeves allow the jets to clean closer to the profile
- Where it is necessary to reopen and close ports after the initial cycle, two SABS units can be run in tandem

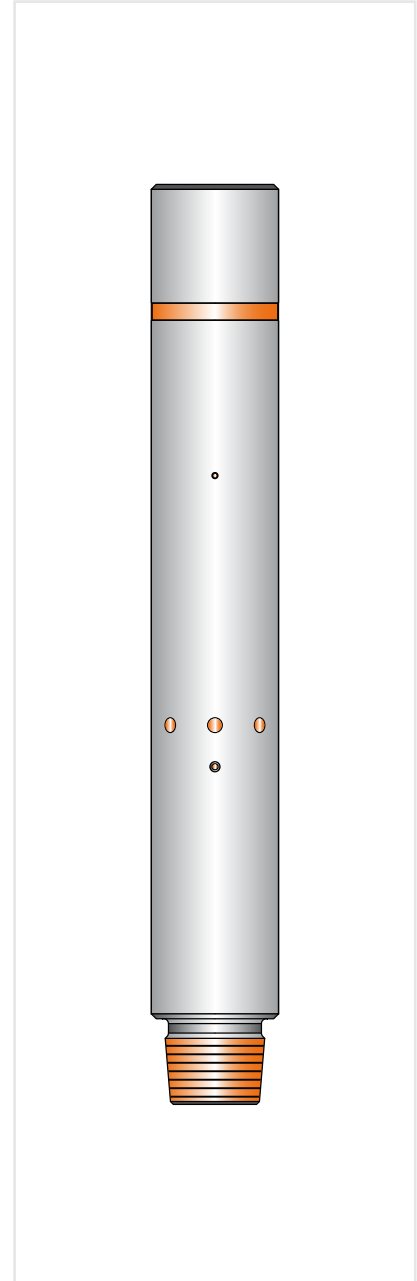

# SHORT TRIP JETTING SUB (STJS)

## Specialized Tools: BOP Cleaning Tools

The SHORT TRIP JETTING SUB (STJS) tool from M-I SWACO is designed for mechanical wellbore cleanup in risers, Blowout Preventers (BOPs) and wellheads, and is well suited for operation from platforms, jackups and land locations.

### Advantages

The STJS unit is suitable for operation from platforms, jackups and land rigs

### Operation

When the STJS tool is in the BOP stack, a maximum of 10 bbl/min should be pumped through the tool. When in the riser, an optimum rate of 25 to 30 bbl/min should be pumped (dependent upon riser ID and drill-pipe OD) to achieve a minimum annular velocity of 80 ft/min (24 m/min) to efficiently carry debris from the well. As much as 25 to 30 bbl/min can be achieved by pumping through the tool

alone or by a combination of pumping through the tool and through the choke/kill/booster lines.

The STJS tool is normally run in conjunction with, and above, the WELL PATROLLER\* or WELL PROTECTOR\* tools. Any pieces of debris that are dislodged, but not circulated out during the cleaning operation, are collected in the WELL PATROLLER or WELL PROTECTOR tools as they fall or are pulled out of hole.

### How it works

The SHORT TRIP JETTING SUB (STJS) unit is equipped with standard drill-pipe box-up/pin-down connections for insertion in a cleanup or drillstring when it is necessary to jet. The tool is generally short-tripped and run in hole and pulled out of hole with the jets open at all times.

### Features

- One-piece mandrel, full drill-pipe strength
- Simple, robust design
- Six replaceable jet nozzles
- Standard drill-pipe box-up/pin-down connections
- Can be used to jet BOP and risers with 11 and 16 in. (279 and 406 mm) sleeves available

### Advantages

- Ball drop is not required to open the tool



# WELLHEAD BRUSHING/JETTING TOOL

## Specialized Tools: Wellhead Cleaning Tools

The WELLHEAD BRUSHING/JETTING TOOL is designed to ensure the multiple profiles of wellheads are clean and free of debris prior to the completion or re-entry. The wellhead area has been widely identified as requiring special attention during wellbore clean up operations. The tool can be used to ensure all profiles are clean, which can reduce the incidence of non-productive time.

### Applications

The WELLHEAD BRUSHING/JETTING TOOL simultaneously performs brushing and jetting functions on wellheads.

### How it works

The WELLHEAD BRUSHING/JETTING TOOL is constructed on a one-piece, full-strength mandrel with box-up/pin-down drill-pipe connections. A brass bristle-impregnated sleeve with jetting slots is mounted on the mandrel and sized for the various ID changes within the hanger area. The sleeve is rotationally locked to the mandrel and provides an annular space for circulation between the ID of the sleeve and the OD of the mandrel. A bearing/diverter ring is mounted at the bottom of the bristle sleeve to act as a “no-go” ring when running in hole.

### Features

- One piece, full strength mandrel
- Brass bristle impregnated sleeve
- Integral jetting slots on tool
- Jetting activated by bearing/diverter ring
- Simple and easy to operate

### Advantages

- Ensures surfaces are cleaned and free of debris before running the completion
- Reduces NPT

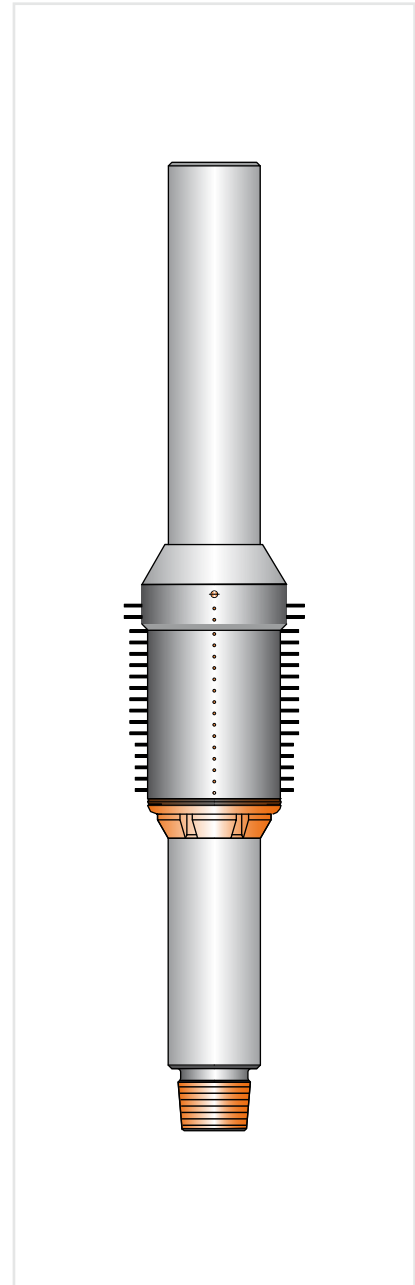

# BYPASS BALL CATCHER (BBC)

## Specialized Tools: Ancillary Tools

The BYPASS BALL CATCHER\* (BBC) tool is a key reason for the operational flexibility of the WELL COMMANDER\* tool and SWITCHBACK\* line of tools. It has the capacity to hold multiple balls for numerous cycles as well as allow smaller balls to pass through to other tools located below.

### Applications

The BYPASS BALL CATCHER tool is run below a WELL COMMANDER valve or SWITCHBACK tool to hold the activation and/or shut-off balls after they have activated or deactivated the tool(s) above it. Additional ball-drop tools can be run below the BYPASS BALL CATCHER tool as long as the OD of the corresponding balls is small enough to pass through the BYPASS BALL CATCHER tool.

### Features

- Fits directly on to pin end of WELL COMMANDER or SWITCHBACK tool
- Captures all balls for retrieval on surface
- Stores captured balls off to one side to allow smaller balls to pass through
- 14 or 18 ball capacities available
- Easily emptied on surface for multiple runs
- Available in 5 in., 7 in., 8¼ in., and 9½ in. OD for all drillstring configurations
- No internal connections

### How it works

As the basis for the flexibility of the WELL COMMANDER and SWITCHBACK tools, the BYPASS BALL CATCHER unit is designed with a unique rail system that guides all balls through and captures only those too large to pass through the rail. All other balls pass freely through and exit the bottom of the BYPASS BALL CATCHER tool. When returned to surface, the captured balls can be easily emptied from the BYPASS BALL CATCHER device, which can be retorqued onto the tool or workstring and used for another run.

### Advantages

- Bypass feature allows flexibility in string design
- Wireline access (depending on size and configuration of the tool string) is possible through the BYPASS BALL CATCHER tool
- Large capacity allows multiple cycles on a single tool run
- Any other ball-drop tools with smaller activation balls can be run below the BYPASS BALL CATCHER unit
- Large flow area does not contribute to increased internal pressure loss.



# LANDING SUB (LS)

## Specialized Tools: Ancillary Tools

Compatible with other tools from M-I SWACO, the LANDING SUB (LS) tool acts as a “no-go” for landing and activating other tools.

### Applications

The LANDING SUB unit can be used to activate an MULTI-FUNCTION CIRCULATING TOOL\* (MFCT) device or act as a “no-go” for other tools. This is usually done on a liner-top polished-bore receptacle or other similar internal-diameter restriction.

### Features

- Lands on liner top, polished-bore receptacle or other suitable shoulder
- One-piece, rugged construction
- No restriction in internal diameter

### How it works

The unit is manufactured from one piece with box-up/pin-down drill-pipe connections and has a central set of large, tapered, fluted outer lugs.

### Advantages

- Designed to be run below an MFCT unit and act as a “no-go” device for activating the tool
- Fluted body for generous fluid bypass



# POSI-DRIFT SUB (PDS)

## Specialized Tools: Ancillary Tools

It is important to check the drift ID of casing while running drill pipe in the well. The POSI-DRIFT SUB (PDS) tool has been designed as the ideal tool to meet this need while not interfering with normal drilling operations or harming the casing.

### Applications

The POSI-DRIFT SUB tool from M-I SWACO is specifically designed to drift the casing not only during drilling but wellbore cleanup operations as well, prior to running the completion equipment. Customized outside diameters can be supplied.

### Features

- One-piece main mandrel
- Free-rotating gauge sleeve
- Standard drill-pipe connections
- Generous fluid/debris bypass
- No square shoulders to hang up in well
- Simple, robust design
- Available for most casing sizes/IDs

### How it works

The machined OD of the gauge sleeve matches the API or a custom drift size of the casing. The tool is built on a one-piece main mandrel with box-up/pin-down drill-pipe connections. The gauge sleeve is free to rotate on the mandrel and remain static when the drill pipe is rotated, preventing wear and/or damage to the casing ID. There are no bolts, threaded-on rings, clamps or welding used in the construction of the tool, so there are no components to loosen and fall off downhole. The tool should be run above other casing-cleaning tools to ensure the casing has been cleaned prior to drifting with the sub.

### Advantages

- The tool has been designed to check the drift of the casing while running drill pipe in the well and during wellbore cleanup operations, prior to running the completion equipment
- Two or more units can be run consecutively to “mimic” a packer or other long completion assembly



# BEARING SUB (BS)

## Specialized Tools: Customized Tools

The BEARING SUB tool allows the entire drillstring to be rotated while circulating with the Standard-Type MULTI-FUNCTION CIRCULATING TOOL\* (MFCT) device in either the open or closed position.

### Applications

In addition to allowing the drillstring to be rotated while circulating with the Standard-Type MFCT device, the BEARING SUB unit from M-I SWACO prevents debris from entering the liner when the BEARING SUB tool is located on the liner top.

### How it works

The sub lands on the liner-top polished-bore receptacle or other suitable shoulder and allows the MFCT tool to be sheared open and remain open while circulating. When resting on the sub's shoulder, the whole string can be rotated as fluid circulated through the MFCT ports. When the string is lifted, the MFCT ports close and the BEARING SUB unit leaves the shoulder and opens the flow path, allowing circulation down the string and up the liner and casing annulus over the liner top. The whole string can still be rotated with the BEARING SUB tool off the liner top.

### Features

- Lands on liner-top polished-bore receptacle or other suitable shoulder
- No internal connections
- No restriction on internal diameter
- Simple, rugged construction
- Fluted mandrel with bronze bearings
- Utilizes AISI steel for body and parts; SAE 660 bronze bearings

### Advantages

- Allows the whole drillstring to be rotated while circulating with the Standard-Type MFCT device
- When the BEARING SUB unit is located on the liner top, prevents debris from entering the liner

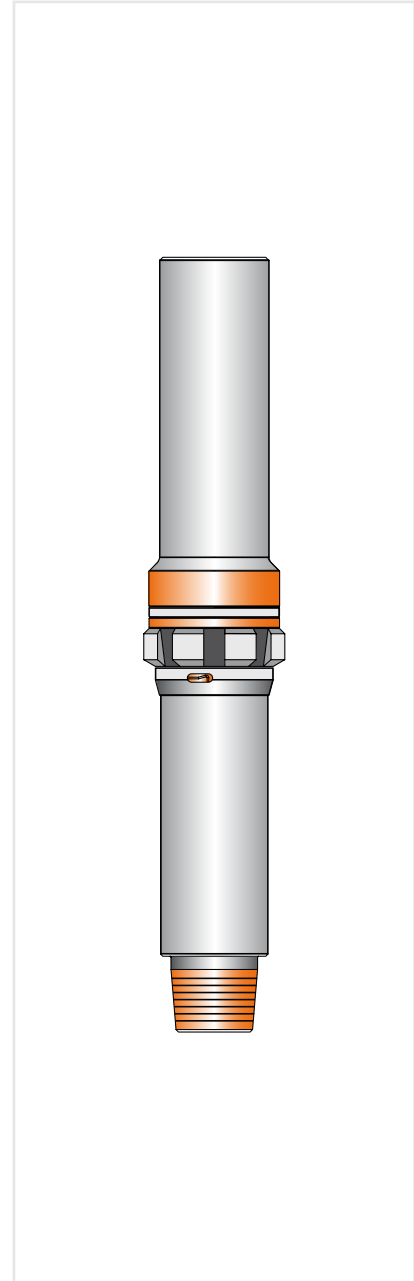

# DISENGAGEABLE MILL ASSEMBLY (DMA)

## Specialized Tools: Customized Tools

The DISENGAGEABLE MILL ASSEMBLY (DMA) tool has been designed to allow liner-hanger-top Polished-Bore Receptacles (PBRs)/Tieback-Bore Receptacles (TBRs) to be cleaned and dressed off with no need for complicated space-out considerations, especially when drilling inside the liner below.

### Applications

The DISENGAGEABLE MILL ASSEMBLY tool from M-I SWACO allows conventional liner-top PBRs/TBRs to be dressed off or cleaned in the normal manner. This unique tool allows two different PBR/TBR combinations to be dressed off on the same run, eliminating a separate trip for each receptacle.

### How it works

After dressing off and cleaning the PBRs/TBRs, additional weight is applied and the inner mandrel of the mill set shears through the mills, allowing the drill pipe above to be tripped in the hole further. The mill set remains in the PBR/TBR to protect the already cleaned receptacles while other drill pipe is tripped in the hole and/or rotated. The ability to disengage through the upper PBR/TBR means that a conventional set of mills can land on another PBR/TBR below the first, and allow it to be dressed in the conventional manner. The disengageability allows drilling-milling to take place in the liner below without “no-going” or landing on the existing liner top and preventing further progress in the hole.

### Features

- Allows two different PBR/TBR combinations to be dressed in one run
- Has a set of “trip buttons” which prevents premature release of the mills from the mandrel
- Enables liner-hanger PBRs/TBRs to be cleaned and dressed without the need for complicated space-out considerations
- Permits drilling in the liner below without “no-going” on PBR/TBR as a restriction

### Advantages

- Saves valuable rig time by eliminating trips
- Drilling is enabled in the liner below without “no-going” on PBR/TBR as a restriction

The DISENGAGEABLE MILL ASSEMBLY unit left behind in the PBR/TBR is then collected by the inner mandrel as the drill pipe is retrieved from the well. A unique feature of the unit is a set of “trip buttons” that prevents the separation of the mills from the mandrel until the mill set is correctly positioned inside the relevant PBR, thus preventing unwanted, unplanned premature release.

When the unit has been located and left inside the PBR, additional “no-go”/ landing subs can be spaced out to land and stop. This allows activation of other weight-set tools such as the MULTI-FUNCTION CIRCULATING TOOL\* (MFCT).

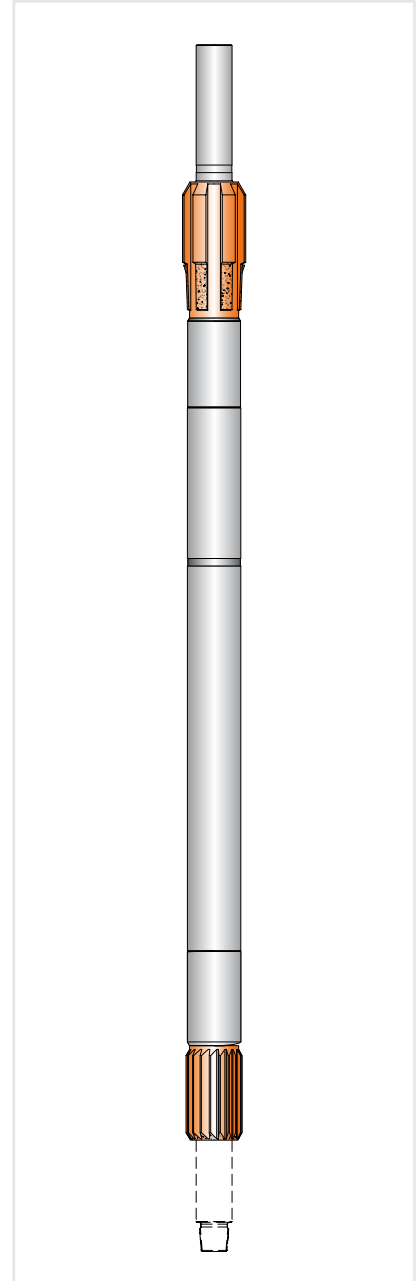



# Disposable BRISTLE BACK (DBB)

## Specialized Tools: Customized Tools

The area in which a plug/packer is to be set often requires thorough cleaning by reciprocation prior to the setting sequence. Having the option to run a drillable cleanup tool in conjunction with drillable and permanent bridge plugs and cement retainers can greatly improve the reliability of the setting operation.

### Applications

In addition to running in conjunction with drillable or permanent bridge plugs or cement retainers, the Disposable BRISTLE BACK\* (DBB) unit from M-I SWACO can be attached to cementing plugs to brush-clean the pipe wall as the plugs are pumped down the casing/tubing during cement-displacement operations.

### How it works

In the case of bridge plugs or cement retainers, the tool is attached to the bottom of the packer. As the device is run in hole to setting depth, it brushes and cleans the casing or tubing. The setting area for the packer or plug can be thoroughly cleaned by reciprocating the device prior to the setting sequence.

The Disposable BRISTLE BACK unit is run in conjunction with drillable or permanent bridge plugs or cement retainers.

### Features

- Removes mud solids, cement sheath and pipe scale
- Available in all common casing/liner sizes
- Supplied with customer-requested connection
- Drillable with polycrystalline or rock bits

### Advantages

- Area for setting plug or packer can be thoroughly cleaned by reciprocation immediately prior to setting

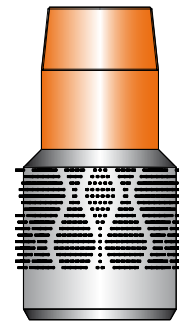

# PRESSURE SHEAR SUB (PSS)

## Specialized Tools: Customized Tools

Sometimes, a reliable source of additional pressure inside the drillstring is required to activate other tools. The PRESSURE SHEAR SUB (PSS) tool is designed to meet this need.

### Applications

The PRESSURE SHEAR SUB (PSS) tool from M-I SWACO is specifically designed to be run in a drillstring to apply temporary pressure for actuating another tool above the PSS, such as a near-bit reamer.

### How it works

The tool consists of a one-piece body with an internal inner- and outer-sleeve arrangement. The tool is run in the initial position, which allows flow through the string. When additional pressure is needed inside the drillstring, the ball is dropped and landed on the inner sleeve. Pressure is then built up behind the ball to activate the other tool above the PSS. Once the other tool has been actuated, the driller increases fluid pressure until the predetermined shear pressure is reached. The inner sleeve shears and moves downward, re-establishing flow to the bit.

The PSS is used to apply additional pressure required to activate other tools in the string.

### Features

- One-piece, full-strength body
- Full pressure integrity – no holes or ports in body
- Ball retained on seat in tool

### Advantages

- Enables pressure to be applied to other tools in the string when required





Protect and preserve fluids quality

**Filtration and Associated Services**

# Completion Fluids Filtration

## Filtration: Filtration Equipment

### A complete service for optimizing your production with solids-free completion fluids

There is hardly any element of drilling a well today that isn't considered "critical" at some point in the well-construction process. This is definitely true of the

completion process and all the elements that comprise it, especially the purity of the completion brines.

Operators have come to rely on the filtration equipment and services from M-I SWACO to deliver solids-free brines in a safe, reliable and cost-efficient manner.

### QHSE features

In addition to being newer than most of our competitors' equipment, our filtration units and other components have been outfitted for worker health and safety as well as environmental protection.

- Pollution pans and curtains
- Certified slings and shackles
- Drilled pad eyes that are certified annually
- Anti-fall devices
- Spill-containment berms
- Can handle zero-discharge fluids such as  $ZnBr_2$
- Stainless steel connections with safety pins
- Hoses tested to maximum working pressure



### Bulk DE delivery system

Since 1998, M-I SWACO has provided the industry's first bulk DE delivery system for extra convenience, safety and health protection. The totally enclosed unit features precise controls and provides a considerable list of advantages.

- Significantly reduces dust inhalation
- No lifting required, eliminates back injuries
- No sack or pallet waste
- Waterproof DE filtering media
- Simple operation and hookup; equipped with air-operated vibrators
- First in the industry
- Fine, medium, coarse DE grades available



Bulk tank



The high-efficiency filtration solutions from M-I SWACO minimize downtime and formation damage while reducing waste and environmental costs

### DE filtration system equipment

The DE units from M-I SWACO utilize a proven design that is recognized not only for its effective filtration but also for reliability, low maintenance and significant environmental safeguards.

- O-ring-gasketed plates
- Blow-down valves maximize fluid recovery
- Curtains minimize spill potential
- Hose construction
  - Open/close ball valves
  - Stainless steel fittings
  - Designed to eliminate spillage of trapped fluids
  - Pressure tested and certified
- Backup hydraulic systems

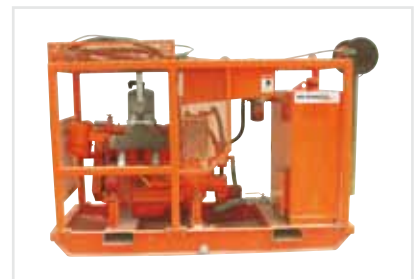

Backup hydraulic power-pack unit

**Oil and grease remediation services**

M-I SWACO can use existing technology to effectively remove organic components that cause failure of static sheen test. This will reduce completion fluid oil and grease values to levels acceptable for discharge.

- Various grades of DE filter media
- Media additives tailored for oil and grease removal
- Specially designed, oil-adsorbing cartridges; one replaces ten 2.5 in. (64 mm) standard cartridges of similar length
- Plant-reclaimed fluids pass oil and grease specification
  - This process has been used successfully on offshore and land locations. M-I SWACO utilizes it to reclaim oil-contaminated fluid returned to its completion fluid plants

**Onshore reclamation services**

After onshore reclamation, M-I SWACO certifies that the levels of oil and grease will meet NPDES permit (or similar) requirements and that reclaimed fluids will meet new-fluids specifications. For fluids with densities greater than 11.6 lb/gal (1.4 kg/L), M-I SWACO

guarantees immediate credit after completion of the wellbore, based upon agreed-to volume and density losses. All charges associated with the disposal of oil, sludge, spent DE and other waste materials resulting from the reclamation are absorbed by the operator.

**Typical service parameters**

Type of Fluid	Expected Solids Loading	Filtration Package
Fresh seawater	Low	2 or 10 micron filters
Light brine: NaCl/KCl	Low	2 or 10 micron filters
Medium-weight brine: CaCl <sub>2</sub> , NaHCO <sub>2</sub>	Low	2 or 10 micron filters
Medium-weight brine: CaCl <sub>2</sub> , CaBr <sub>2</sub>	High	DE and 2 or 10 micron filters
Heavy-weight brine: NaBr, CaBr <sub>2</sub> , KHCO <sub>2</sub>	Low/high	DE and 2 or 10 micron filters
Very heavy-weight brine: ZnBr <sub>2</sub> , CsF, NaHCO <sub>2</sub>	High	DE and 2 or 10 micron filters



Dual pod unit

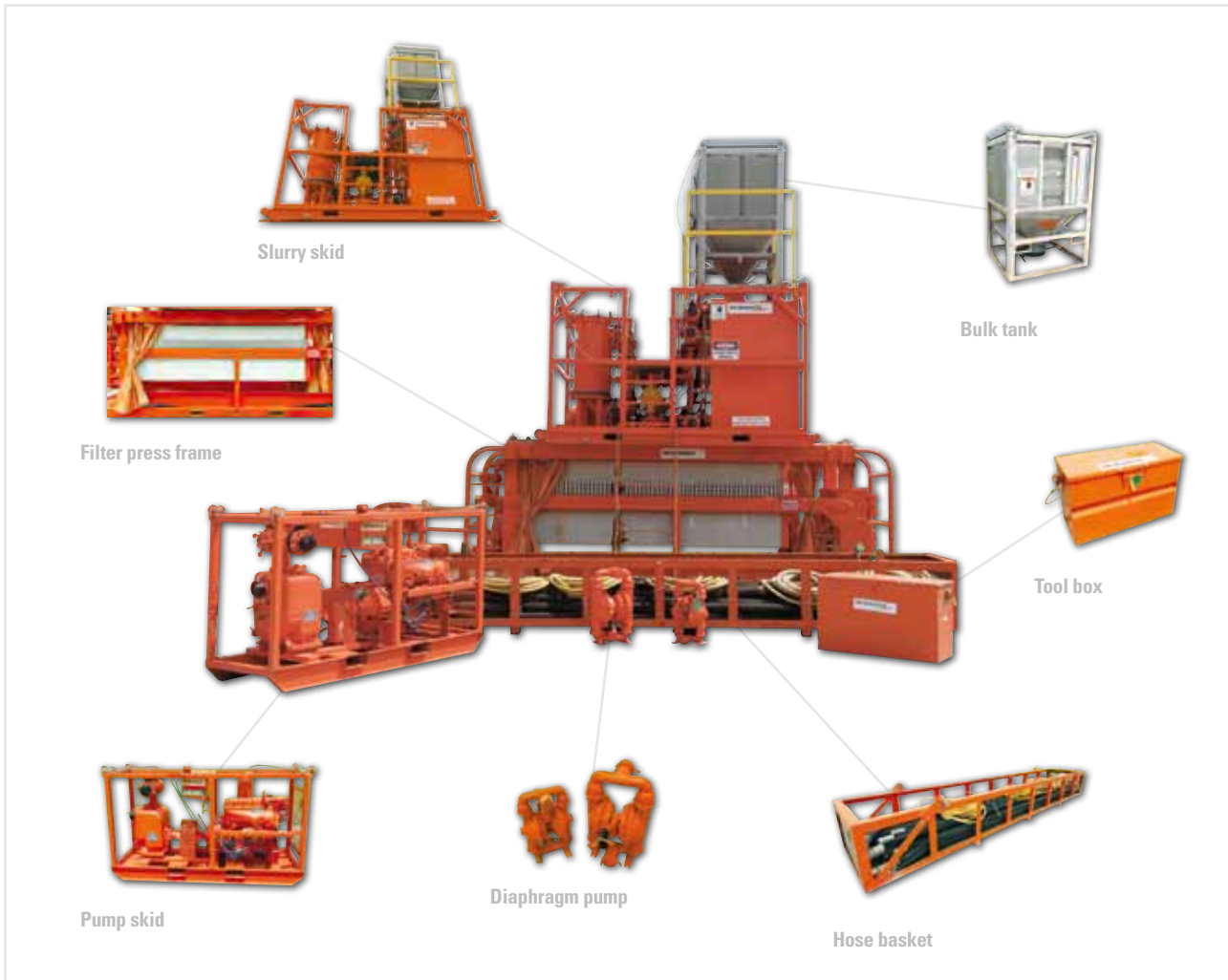

### Features and advantages

- New, well-maintained equipment
- Customizable DE filtration
- Specially designed cartridge filtration
- Flexible equipment configurations
- Well-trained technicians
- Oil and grease remediation
- Filtration solutions for all brines
- Bulk DE delivery system
- Greater filtration efficiency
- Less waste
- Environmental compliance
- Healthier working environment
- Two chemical-injection diaphragm pumps
- Platinum-grade cartridges – 33% more efficient than standard stick-type
- Thiocyanate removal
- DE filtration press and slurry skids are stackable for tight spaces
- Backup hydraulic pump

# DE Filtration Units plate and frame skid

## Filtration: Filtration Equipment



### Safety and operational considerations

- M-I SWACO provides ladders with each unit
- Retractable lanyard fall-protection devices
- Slurry skids equipped with handrails
- Diatomaceous Earth (DE) bulk tanks reduce back injuries associated with handling sacks
- Safe working and operating conditions require 3 ft (0.9 m) clearance around equipment
- All DE filtration presses and slurry skids stackable
- Maximum filtration rates 12 to 14 bbl/min (1.9 to 2.2 m<sup>3</sup>/min) (clean fluid with little or no solids). Accounting for solids and density, the average filtration rate is 10 bbl/min (1.6 m<sup>3</sup>/min). Factors that affect filtration rates are density, viscosity and solids loading. Mechanically, filtration rates are decreased as the length of the pump suction increases
- Average DE filtration capacity (lb/bbl) depends upon viscosity, density and solids loading
- Average number of filtration cycles depends upon viscosity, density and solids loading

### Operating specifications

- Cake thickness, in. (mm): 1¼ (32)
- Plate size, in. (mm): 47 x 47 (1,200 x 1,200)
- Filter cloths/polypropylene with sewn-in, high-density cord for caulked-in-place installation
- Recessed, center-feed, alternating four-corner discharge
- Material of construction: polypropylene
- Gasket sealing area with EPDM elastomer O-ring-type gaskets
- Fully ported
- Maximum operating pressure 100 psi (7 bar) @ 120°F (49°C) operating temperature

### Filter press frame

- Oil-rig-style
- Design pressure: 100 psi (7 bar)
- Full-width, 304 stainless steel sidebar caps
- 304 stainless steel sluice pan, welded in place: 36 in. (914 mm) deep with 12 in. (305 mm) slope end to end
- Lifting eyes certified tested
- Mounting pad for sluice pump
- Forklift slots in base





### Hydraulic closing system

- Double-acting hydraulic cylinder
- Stainless steel cylinder rod
- Dual Haskel<sup>^</sup> hydraulic pumps

### Paint system

- White sandblast to SSPC-SP10 material preparation
- Special, three-coat Carboline<sup>^</sup> paint system

### Feed and discharge manifold

- Material of construction: schedule 20, 304 stainless steel
- PVC butterfly valves
- 4 in. (102 mm) inlet and outlet connections
- Manual valve actuation



### Slurry skid

- Size, L x W x H, ft (m): 14 x 8 x 7.5 (4 x 2 x 2.29)
- Weight, lb (kg): 8,000 (3,629)
- Equipped with a dual-pod cartridge unit containing a total of 10 uniquely designed, 6½ in. (165 mm) OD, platinum-grade cartridges or 30 standard, 2½ in. (64 mm) OD cartridges. (Platinum-grade cartridges are 33% more efficient than standard stick-type)
- Each cartridge is 40 in. (1,016 mm) long
- It takes approximately 10 min to change a set of 10 cartridges; easy disposal
- The slurry skid may be stacked on top of the filter press
- Ladder and retractable lanyard device for fall protection included



### Pump skid

- Size, L x W x H, ft (m): 10.42 x 3 x 6.42 (3.18 x 0.9 x 1.96)
- Weight, lb (kg): 3,500 (1,587)
- Engine manufacturer: Deutz<sup>^</sup>
  - Displacement, in.<sup>3</sup> (cc): 353/371 (5,785/6,080)
  - Output, hp: 85
- Pump manufacturer: Gorman-Rupp<sup>^</sup> UBB60-B
  - Size, in. (mm): 4 x 4 (102 x 102)
  - Self-Priming Centrifugal
  - Output: 14½ bbl/min @ 75 psi (5 bar)
- The 1600, 1500, 1200 and 800 DE filtration presses and slurry skids are stackable
- Maximum filtration rates are 12 to 14 bbl/min (1.9 to 2.2 m<sup>3</sup>/min) for clean fluid with little or no solids-loading; lower with increased solids-loading

<sup>^</sup>Haskel is a mark of Haskel International, Inc.

<sup>^</sup>Carboline is a mark of Carboline Company.

<sup>^</sup>Deutz is a mark of Deutz AG Corporation.

<sup>^</sup>Gorman-Rupp is a mark of Gorman-Rupp Company.



### Miscellaneous and safety equipment

#### DE Bulk Tanks

- Size, L x W x H, ft (m): 4 x 5 x 7.42 (1 x 2 x 2.26)
- DE bulk tanks hold 1,800 lb (816 kg) of DE
- DE bulk tanks weigh 850 lb (386 kg) empty

#### DE Sack Material

- DE available in 25 and 50 lb (11 and 23 kg) sacks



#### Chemical Injection Diaphragm Pump

- Type: Air
- Size, in. (mm): 2 (51) and 3 (76)
- Manufacturer: Versa-Matic<sup>^</sup>



#### Hose Basket

- Size, L x W x H, ft (m): 22 x 4 x 3 (7 x 1 x 0.9)
- Weight, lb (kg): 4,500 (2,041)
- Hose lengths and sizes:
  - Most hoses are available in 20 ft (6.1 m) sections rented by the foot
  - 4 in. (102 mm) suction and discharge hose with stainless steel safety lock camlock connections
  - 3 in. (76 mm) suction and discharge hose with stainless steel safety lock camlock connections
  - 2 in. (51 mm) suction and discharge hose with stainless steel safety lock camlock connections
- All hoses are pressure-tested, certified and have stainless steel connections
- 1 in. (25 mm) air hose with brass safety crow connection is available in 25 and 50 ft (8 and 15 m) sections

<sup>^</sup>Versa-Matic is a mark of Versa-Matic Tool, Inc.

<b>Specifications</b>				
<b>Filtration unit</b>	<b>1,600 ft<sup>2</sup> DE Filtration Unit (149 m<sup>2</sup>) plate and frame skid</b>	<b>1,500 ft<sup>2</sup> DE Filtration Unit (139 m<sup>2</sup>) plate and frame skid</b>	<b>1,200 ft<sup>2</sup> DE Filtration Unit (111 m<sup>2</sup>) plate and frame skid</b>	<b>800 ft<sup>2</sup> DE Filtration Unit (74 m<sup>2</sup>) plate and frame skid</b>
Unit size, ft <sup>2</sup> (m <sup>2</sup> )	1,600 (149)	1,500 (139)	1,200 (111)	800 (74)
Plates	64	60	45	33
Manufacturer	JWI <sup>^</sup> (Siemens <sup>^</sup> )	JWI (Siemens)	JWI (Siemens)	JWI (Siemens)
Size, L x W x H, ft (m)	23.25 x 9 x 7.75 (709 x 3 x 2.36)	23.25 x 9 x 7.75 (709 x 3 x 2.36)	22 x 4 x 7.17 (7 x 1 x 2.19)	16.75 x 4.76 x 7.17 (5.11 x 1.5 x 2.19)
Weight, lb (kg)	24,000 (10,886)	24,000 (10,886)	22,000 (9,979)	20,000 (9,072)
Filtration surface area, ft <sup>2</sup> (m <sup>2</sup> )	1,600 (149)	1,500 (139)	1,200 (111)	800 (74)
Design operating pressure, psi (bar)	100 (7)	100 (7)	100 (7)	100 (7)

<sup>^</sup>JWI is a mark of Siemens Water Technologies Holding Corp.

<sup>^</sup>Siemens is a mark of Siemens Aktiengesellschaft Corporation.

# Equipment

## Filtration: Filtration Equipment



### Centrifugal pump

- 4 x 4 ft (1 x 1 m) NPT female connections
- Open-type, 6-vane impeller 40-50-18 ductile iron
- No. 20 gray-iron casing (max. operating 130 psi [9 bar])
- Handles 1½ in. (29 mm) spherical solids
- Oil sight glass
- Brass pressure-relief valve
- Oil-lubricated silicon carbide vs. tungsten carbide mechanical seal
- Maximum temperature of liquid pumped: 160°F (71°C)
- Buna N O-ring
- Double discharge fitting of stainless steel material
- Dodge<sup>^</sup> Para-Flex<sup>^</sup> coupling



### Cargo boxes

- Unit size L x W x H, ft (m): 6 x 6 x 9.33 (2 x 2 x 2.84)
- Weight, lb (kg) empty: 8,000 (3,629)



### Dual pod unit

- Skid size L x W x H, ft (m): 7 x 3 x 6.5 (2 x 1 x 1.98)
- Weight, lb (kg): 2,000 (907)
- Number of cartridges: 10
- Hoses (25 ft [7.6 m] sections): 25 ft (7.6 m) of suction and 25 ft (7.6 m) of discharge



### M-I SWACO blending tank

- Size, L x W x H, ft (m): 9.42 x 8 x 9.5 (2.87 x 2 x 2.9)
- Weight, lb (kg): 6,000 (2,722)
- Capacity, bbl (m<sup>3</sup>): 65 (10.3)
- Jetted chemical hopper

### Hydraulic power pack

- Size, L x W x H, ft (m): 7.5 x 3.42 x 5 (2.29 x 1.04 x 1.52)
- Weight, lb (kg): 4,000 (1,814)
- Engine manufacturer: Deutz
  - Displacement, in.<sup>3</sup> (cc): 353/371 (5,785/6,080)
  - Output, hp: 72
  - Panel with oil-pressure and temperature gauges equipped with safety shutdown
  - Cast-iron manifold
  - Spark-arrestor muffler
  - Manual Chalmatic air intake shutdown
  - Oil-bath air cleaner
  - V-belt shutdown
  - Hand throttle, rigid mounts
  - PTO clutch
- Hoses (hydraulic hoses), ft (m): 80 (24)

<sup>^</sup>Dodge and Para-Flex are marks of Baldor Electric Company.

# Filter Press Package (Unit)

**Filtration: Filtration Equipment**

The Filter Press Unit is used as part of a filter package and is typically the first point of filtration for completion brines.

## Applications

Inexpensive Diatomaceous Earth (DE) filter media is used in the Filter Press Unit from M-I SWACO to remove heavy solids contamination from high volumes of brines.

## How it works

The Filter Press Unit is always used with a guard filter placed downstream to catch any possible DE bleed-off. When a twin-vessel cartridge unit is used downstream from the Filter Press Unit, it provides a polish filter.

## Features

- Gasketed polypropylene filter plates and cloths for zero fluid loss
- Hydraulic-ram closure with pneumatically powered hydraulic pump and manual standby pump in case of air-supply failure
- Compact, rugged carbon steel construction with transport/lifting frame and slings
- Integral slurry pan for wash-down of filter cake
- Inlet/outlet manifold in 316 stainless steel complete with blowdown system for fluid recovery

## Advantages

- Removal of heavy solids contamination from high volumes of fluid



# FILTER FLOC

**Filtration: Filtration/Reclamation Chemistry**

FILTER FLOC\* polymer is a suspension designed to flocculate residual displacement solids in a manner that facilitates removal from a brine-base completion fluid. By flocculating the residual displacement solids, the contaminant can be easily transported

to the surface and removed through the brine filtration process.

For completion fluid applications, FILTER FLOC polymer is applied as a spacer in the displacement train. FILTER FLOC additive is intended for use in freshwater, seawater, monovalent,

and calcium brine fluids. FILTER FLOC additive can also be utilized in the reclamation of completion fluid brines. For reclamation applications, optimum FILTER FLOC polymer additions are determined through pilot testing.

# SAFE-FLOC I

## Filtration: Filtration Equipment/Filtration/Reclamation Chemistry

### Advantages

- Can be separated from the carrier fluid by gravity separation, minimizing environmental impact
- Significantly reduces filtration and displacement time, saving rig costs
- Water dispersible

SAFE-FLOC\* I flocculant and filtration aid is a blend of ionic and nonionic surfactants, flocculants and high flash-point solvents designed to flocculate and suspend insoluble iron solids. These iron solids normally come from fluid reaction with the mill scale left on the drill pipe, casing or, other tubular products in the wellbore. The solids are made oil-wet, emulsified and carried away from the surfaces of the steel pipe. This mechanism ensures that the solids remain in suspension and are carried out of the wellbore or float to the surface of a tank. The water or brine below the surface is decontaminated allowing faster filtration rates and longer filtration cycles.

### Applications

SAFE-FLOC I flocculant and filtration aid is designed specifically for use in oil and gas wells for clean-up prior to the start of production and as a filtration aid. Applied as a spacer, it is used as a solution in fresh or seawater in solutions between 1 and 3% by volume. Higher concentrations may be used where higher levels of iron exist in the wellbore. It can also be used in the reclamation process of heavy brine systems.

No claim of personal safety is intended nor implied by the use of the name SAFE in this product. Personnel handling this material should read and follow all safety and handling procedures set forth in the Material Safety Data Sheet.

# SAFE-FLOC II

## Filtration: Filtration Equipment/Filtration/Reclamation Chemistry

SAFE-FLOC\* II flocculant and filtration aid is a blend of surfactants and solvents designed to suspend solids from oil-base drilling fluid and transport them from the well. Solids from the drilling mud, pipe dope and mineral scale are made oil-wet and emulsified. This mechanism ensures that the solids remain in suspension and are carried out of the well.

### Applications

The SAFE-FLOC II flocculant and filtration aid is designed specifically for downhole use in oil and gas wells for clean-up prior to the start of production

and as a filtration aid. It can also be used to flocculate dispersed mud solids in a completion fluid and float the solids to the surface of a holding tank. This allows the fluid below the surface to be filtered at a much faster rate and with longer filtration cycles.

The flocculant and filtration aid is applied as a spacer, it is used as a solution in fresh or seawater in solutions between 1 and 4% by volume. Higher concentrations may be used where higher levels of hydrocarbon exist in the mud to be displaced.

### Advantages

- Solids are made oil-wet and emulsified to ensure they are removed from the wellbore
- Can be separated from the carrier fluid by gravity separation, minimizing environmental impact
- Significantly reduces filtration and displacement time, saving rig costs

No claim of personal safety is intended nor implied by the use of the name SAFE in this product. Personnel handling this material should read and follow all safety and handling procedures set forth in the Material Safety Data Sheet.

## Technology Centers

### Houston, TX

Tel: 281-561-1300

Fax: 281-561-1441

### Westhill, Scotland

Tel: 44-1224-742-200

Fax: 44-1224-742-288

### Broussard, LA

Tel: 337-837-8655

Fax: 337-837-5812



**Mi SWACO**  
A Schlumberger Company

This information is supplied solely for informational purposes and M-I SWACO makes no guarantees or warranties, either expressed or implied, with respect to the accuracy and use of this data. All product warranties and guarantees shall be governed by the Standard Terms of Sale. Nothing in this document is legal advice or is a substitute for competent legal advice.

P.O. Box 42842  
Houston, Texas 77242-2842  
[www.miswaco.slb.com](http://www.miswaco.slb.com)  
Email: [questions@miswaco.slb.com](mailto:questions@miswaco.slb.com)