



For a balanced
planet

Contents

Climate Action⁰⁸

People²¹

Nature³¹

Introduction

- 03 → About us
- 04 → CEO & CSSO Introduction
- 05 → Annual Highlights

Our Approach

- 06 → Our Approach to Sustainability

Climate Action

- 08 → Climate Action Introduction
- 09 → Our Roadmap to Net Zero
- 14 → Decarbonizing Customer Operations
- 17 → New Energy and Transition Opportunities

People

- 21 → People Introduction
- 22 → Creating In-Country Value
- 24 → Respecting Human Rights
- 26 → Promoting Talent and Diversity, Equity, and Inclusion

Nature

- 31 → Nature Introduction
- 32 → Safeguarding Biodiversity
- 34 → Protecting Natural Resources
- 38 → Enabling Circularity

Governance

- 42 → Governance Introduction
- 43 → Ethics & Compliance
- 45 → Stakeholder Engagement
- 47 → Responsible Supply Chain
- 50 → Quality, Health, Safety, and Environment (QHSE)
- 53 → Data Privacy and Cybersecurity

Data

- 55 → Sustainability Accounting Standards Board (SASB) Index
- 57 → GRI
- 61 → TCFD
- 68 → 2023 Performance Data

About us

“A remarkable year of broad, resilient, and durable growth. Our performance and returns-focused strategy, combined with our differentiated market positioning and digital capabilities, will drive profitable growth and further margin expansion, building on a strong foundation for long-term growth.”

Olivier Le Peuch
CEO



2023 Financial Highlights

Total revenues
\$33.14_B
(18% increase year on year)

Net income attributable to SLB
\$4.20_B
(22% increase year on year)

Adjusted EBITDA
\$8.11_B[†]
(25% increase year on year)

Cash flow from operations
\$6.64_B

Free cash flow
\$4.04_B[†]

Returned to shareholders
\$2_B
through dividends and stock repurchases

[†] For definitions of adjusted EBITDA and free cash flow, as well as reconciliations of these non-GAAP measures to their most comparable GAAP measures, please see our fourth-quarter and full-year 2023 results earnings press release [here](#).



Three Engines of Growth

Core

In 2023, performance across our Core business, comprising Reservoir Performance, Well Construction, and Production Systems, was fueled by strong growth in the international and offshore markets. SLB continued to benefit from long-cycle developments, capacity expansions, and exploration and appraisal activities, particularly in the Middle East, where revenue reached a record high, and across offshore basins in Brazil, Angola, US Gulf of Mexico, Guyana, and Norway. We expect the breadth, resilience, and durability of the current upcycle to continue, supported by the imperative of energy security to meet rising global demand.

Digital

Digital continued its strong growth momentum, delivering more than \$2 billion in revenue. Our success in Digital was driven by further adoption of our new digital technology platforms – comprised of cloud, edge, and AI – as more customers embrace the integration of connected and autonomous drilling, data, and AI solutions.

New Energy

New Energy offers a significant opportunity to use SLB’s experience and scale to drive innovation for a low-carbon economy beyond oil and gas. We continued building businesses and forging partnerships across industries to focus on five key areas: carbon capture and storage (CCS), geothermal and geoenery, critical minerals, energy storage, and hydrogen.

CEO and CSSO Introduction

Delivering value

Today and tomorrow



When we rebranded in 2022 to become SLB, it was with the bold vision to drive energy innovation for a balanced planet. Since then, our belief that the energy industry must play a leading role in addressing the global energy trilemma – ensuring security, affordability, and sustainability – has only strengthened. SLB is redefining the role that a global technology company can play in the energy transition, and this continues to inspire new levels of innovation across our three engines of growth: Core, Digital, and New Energy.

In our Core, we are leveraging nearly a century of subsurface expertise to drive the future of energy operations, developing and deploying innovative technologies to produce energy more efficiently with fewer emissions. In Digital, we are unleashing the power of data and AI to help customers achieve new levels of productivity and performance while ushering in a new era of automation. And in New Energy, we are fast-tracking breakthroughs in the critical areas of carbon capture and storage as well as geothermal energy.

Our achievements in each of these areas are driving our impressive financial performance, and we concluded the year by achieving widespread revenue growth, margin expansion, and exceptional free cash flow. These strong results enabled us to return \$2 billion to shareholders through dividends and share repurchases in 2023. With continued growth in earnings, our proven ability to generate cash, and confidence in the long-term outlook, we are targeting to return at least \$2.5 billion to shareholders in 2024.

The common thread that weaves between these accomplishments is that we are growing our business by embedding sustainability in everything that we do. This year, we reduced our emissions intensity – the amount of carbon emissions produced per dollar of revenue – across Scope 1, 2, and 3, and we helped our customers avoid over 830,000 metric tons of CO₂e emissions through our portfolio of Transition Technologies™.

These results highlight the influence of our low-carbon solutions in accelerating our positive environmental impact as we enable new levels of efficiency and performance. As the energy transition progresses, our ability to deliver value while supporting our sustainability focus areas of climate action, people, and nature will be a defining factor for our growth.

Reflecting on 2023, the early impact of our transformation is evident. Our impressive full-year results reflect the performance of our teams, the support of our partners, and the loyalty of our customers. And our ongoing success underscores the differentiated technology we deliver and the trust our stakeholders place in us.

With a clear vision and firm strategy in place, we remain committed to the global energy transition and unlocking access to energy for the benefit of all. Moving forward, we will continue to seize new growth opportunities, diversify our offerings, strengthen our market position, and uphold our sustainability commitments – all in support of a balanced planet.

Olivier Le Peuch
Chief Executive Officer

Katharina Beumelburg
Chief Strategy and Sustainability Officer



Olivier Le Peuch
Chief Executive Officer

Katharina Beumelburg
Chief Strategy and Sustainability Officer

2023 Highlights

2023 Wall Street Journal Best Managed Companies. Learn more [here](#).

2023 Services Company of the Year at Energy Council Awards of Excellence. Learn more [here](#).

SLB Named a Top Socially Responsible Dividend Stock. Learn more [here](#).

SLB Recognized as One of the Best Places to Work in 2024 'Glassdoor'. Learn more [here](#).

ESG Performance

MSCI: AA

Sustainalytics: 20.3

CDP: Climate B

* On October 2, 2023, SLB completed the acquisition of the Aker Solutions subsea business. All emissions attributable to this acquired business are excluded from our 2023 GHG emissions reporting.



FATALITY FREE

Zero employee or contractor fatalities.



PEOPLE

Human Rights

52 SLB facilities underwent human rights due diligence worldwide.



CLIMATE ACTION*

15%

reduction in Scope 1 & 2 emissions intensity from 2022.

13%

reduction in Scope 3 emissions intensity from 2022.



NATURE

Biodiversity

Performed a comprehensive biodiversity risk assessment.



NATURE

Water Stewardship

Improved our water measurement capabilities for usage and tracking in 100% of our facilities, and in specific business lines with high water consumption.

Our Approach to Sustainability

Change starts with us



Recognizing that under any scenario, oil and gas will remain an important part of the energy mix for decades, SLB is forging the road ahead in a complex energy transition that must balance reducing emissions with meeting the world's growing energy demands. To meet this global energy challenge, SLB has embedded sustainability in everything we do, setting ambitious goals to deliver measurable environmental and social progress and partnering with customers, suppliers, and peers to accelerate impact.

Change starts with us. We're acting now, and acting quickly, to reduce our own emissions. SLB was the first company in the industry to announce a comprehensive 2050 net zero commitment, inclusive of Scope 1, 2, and 3 emissions across our entire value chain, with a clear timeline for interim reductions along the way. With 2019 as our base year, we reduced our Scope 1 and 2 emissions intensity by 15%* and Scope 3 by 13%* in 2023 from 2022, in support of our interim targets of 30% reduction in absolute emissions for Scopes 1 and 2 by 2025 and for Scope 3 by 2030.

By linking our sustainability goals to the strategy of the company, SLB is driving real change, with a balanced approach focused on delivering energy for today and tomorrow. In our core operations, we are helping our customers produce more energy with fewer carbon emissions, while our long-term ambition for New Energy is to develop energy systems that can reduce hundreds of megatons of emissions.

But we know we can't do this alone. SLB is forging partnerships across sectors, geographies, and stakeholders to develop technology solutions and drive progress together, for the benefit of all.



[Learn more here](#)

Our Sustainability Priorities

Our sustainability strategy is focused on three priorities with the greatest potential impact for SLB, our stakeholders, and society: [climate action](#), [people](#), and [nature](#). Supporting our priorities are our enablers – governance and empowering local teams – and our accelerators – technology and innovation and partnerships.



No
One
size
fits all

Our sustainability reporting is guided by our stakeholders and third-party frameworks, including:

- Sustainability Accounting Standards Board (SASB)
- Task Force on Climate-Related Financial Disclosure (TCFD)
- UN Sustainable Development Goals (SDGs)
- UN Guiding Principles on Business and Human Rights Reporting Framework
- Global Reporting Initiative (GRI)

We take a 'no one size fits all' approach to sustainability, and our local teams are aligned globally and empowered to use the UN SDGs as a framework to identify different value creation possibilities in connection with business and stakeholder activities. Supported by our global network of sustainability champions, our teams design and deliver innovative, scalable, and replicable sustainability programs that have local impact.



Climate Action

Our continued commitment to climate action remains unwavering as we continue to evolve our brand, placing climate initiatives at the core of our corporate strategy. As a global technology company driving energy innovation, we are dedicated to contributing to a balanced planet.

Our vision is centered on defining and driving high performance and sustainability. We recognize the urgent need to act swiftly in order to decarbonize the world's energy system, sharing the responsibility to create a resilient and low-carbon future.

Our comprehensive strategy for advancing energy transition revolves around three key areas: our roadmap to net zero, decarbonizing customer operations, and new energy and transition opportunities. We are at the forefront of what needs to happen, applying acceleration through technology innovation and digital solutions.

Net Zero

2023 Highlights:

15%*

Scope 1 & 2 emissions intensity reduction from 2022

13%*

Scope 3 emissions intensity reduction from 2022

35%

renewable energy in our facilities

830,000 TCO₂e

avoided emissions with SLB Transition Technologies



Our Roadmap to Net Zero

In 2023, we executed on our overarching strategy to reduce our carbon emissions and energy usage across our value chain. Our strategic focus expanded across Scope 1, 2, and 3 emissions.



3
2
1



We extended our internal digital capabilities with our comprehensive digital platform to track greenhouse gas (GHG) emissions and provide visibility to decision makers across our operations and facilities. This was a critical tool in monitoring our progress towards our Scope 1 and 2 performance objectives in 2023. This visibility and associated actions are key reasons why our Scope 1 and 2 emissions intensity per US dollar of revenue decreased by 15%* from 2022 to 2023, effectively offsetting the effects of our business growth on our absolute emissions.

To operationalize our net zero commitment and motivate our employees to take climate action, we introduced company wide sustainability key performance objectives (KPOs) focused on Scope 1, 2, and/or 3 emissions intensity reduction. This was accompanied by an engagement campaign, and the launch of our 'Understanding SLB Emissions and Decarbonization Pathways' online training program. In addition, our executive leadership team shares a Scope 3 intensity-reduction KPO.



[Learn more here](#)

Our Roadmap to Net Zero

SLB is committed to achieving net zero greenhouse gas emissions by 2050 aligned with science-based methodology and the 1.5 °C target of the Paris Agreement.

30%
reduction in Scope 1 and 2 by 2025

50%
reduction in Scope 1 and 2 by 2030

30%
reduction in Scope 3 by 2030

Net Zero
by 2050

All reduction targets are measured against our 2019 baseline.

Our Roadmap to Net Zero continued

Continuing with the long-term upstream and downstream actions in 2023 across our value chain to reduce our Scope 3 emissions, we reduced our Scope 3 emissions intensity by 13%* from 2022. Even though we saw this improvement in our emission intensity, our overall Scope 3 emissions increased in two main areas, purchased goods and services and technology use, due to significant business growth.

Based on our detailed understanding of our emissions footprint, business growth, and emissions reduction actions and constraints, we've built comprehensive Scope 1, 2, and 3 roadmaps out to 2030 including high confidence pathways to meet our commitments in 2025 and 2030.

● SPOTLIGHT

Understanding SLB Emissions and Decarbonization Pathways

In 2023, we developed and rolled out a companywide eLearning course, "Understanding SLB Emissions and Decarbonization Pathways." This training describes SLB's net zero commitment, explains what Scope 1, 2, and 3 emissions are and how they apply to SLB's business, defines the actions SLB has taken to calculate and control emissions within its operations, explains how SLB's emissions reduction actions impact our customers' emissions, and describes actions that SLB employees can take in their day-to-day jobs to decarbonize the oil and gas industry.



● SPOTLIGHT

Emissions Quantification Tools

SLB is empowering employees to develop emissions quantification tools to support business decisions. These tools calculate the GHG footprint of SLB operations, services, or products, often measured by job or activity. They also provide data to help SLB make product and service development decisions and to help our clients evaluate the GHG impact among product and service offerings. To ensure emissions data integrity and transparency internally and externally, we have implemented a governance process to validate these tools.

● SPOTLIGHT

Internal Carbon Pricing in Business Evaluation

In 2023, we piloted internal carbon pricing in our process of evaluating new business for high-emitting operations tenders, comparing contract emissions intensity to business line and corporate targets.

Our Roadmap to Net Zero continued

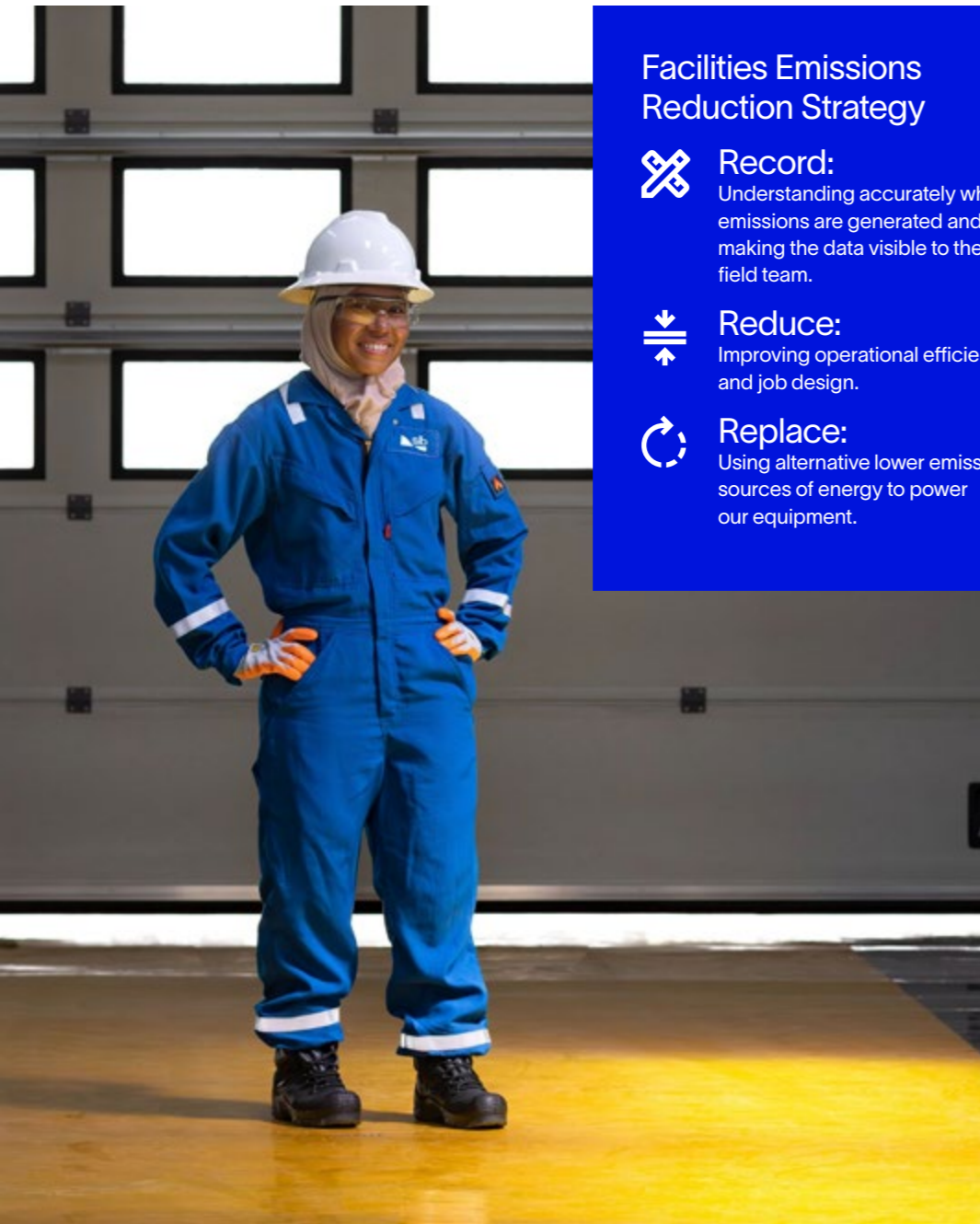

Facilities Emissions Reduction Strategy

- Record:** Understanding accurately where emissions are generated and making the data visible to the field team.
- Reduce:** Improving operational efficiency and job design.
- Replace:** Using alternative lower emission sources of energy to power our equipment.

Scope 1 and 2

In 2023, our Divisions worked to increase the efficiency of their operations and substantially reduce the associated Scope 1 and 2 emissions, achieving a flat absolute emissions profile despite the organization's growth during 2023.

Reducing GHG emissions in Field Operations

In 2023, our field operations team continued to progress on their path to net zero emissions.

In a pilot study in Argentina, we completed a group of four wells where 142 stages were pumped. The operator improved efficiency by an average of 24% in stages completed per day in comparison with other pads that year and saw a 67% improvement compared with overall performance two years earlier. A record-setting 20 stages per day was achieved, along with an estimated 28% reduction in emissions resulting from reduced engine idle time.

Reducing GHG emissions in Our Facilities

In alignment with SLB's science-based targets and commitment to sustainability, our Facility Management focuses on a proactive "record, reduce, and replace" strategy.

We use the principles and guidance established in The Greenhouse Gas Protocol: A Corporate Accounting and Reporting Standard (Revised Edition) to calculate our annual CO₂e emissions in SLB. As part of the process, we apply emission factors and Global Warming Potential (GWP) factors to energy consumption and spend data to derive CO₂e values. The GWP factors are taken from the IPCC Fifth Assessment Report (AR5 – 20 year and 100 year).

See [2023 Performance Data table](#) for total absolute GHG emissions for 2019 (baseline), 2022, and 2023.

● SPOTLIGHT

Renewable Fuels to our Fleets

SLB field activity is often in remote locations with limited access to electricity. As an alternative, we are actively identifying opportunities and introducing renewable fuels to our fleets to lower the emissions intensity of our operations. In 2023, we accelerated a multiyear program in Indonesia to use biodiesel mixtures to power heavy duty equipment, reducing the carbon footprint of the operation. Additionally, we initiated a pilot project to use biodiesel in our field equipment in Oman in partnership with our customers.

GHG EMISSIONS INTENSITY IN METRIC TONS OF CO₂e PER THOUSAND DOLLARS OF REVENUE*

	2019 baseline	2022	2023
Scope 1 and 2	0.070	0.064	0.054
Scope 3	1.348	1.241	1.075
Total (Scope 1, 2, and 3)	1.419	1.304	1.129

Our Roadmap to Net Zero continued

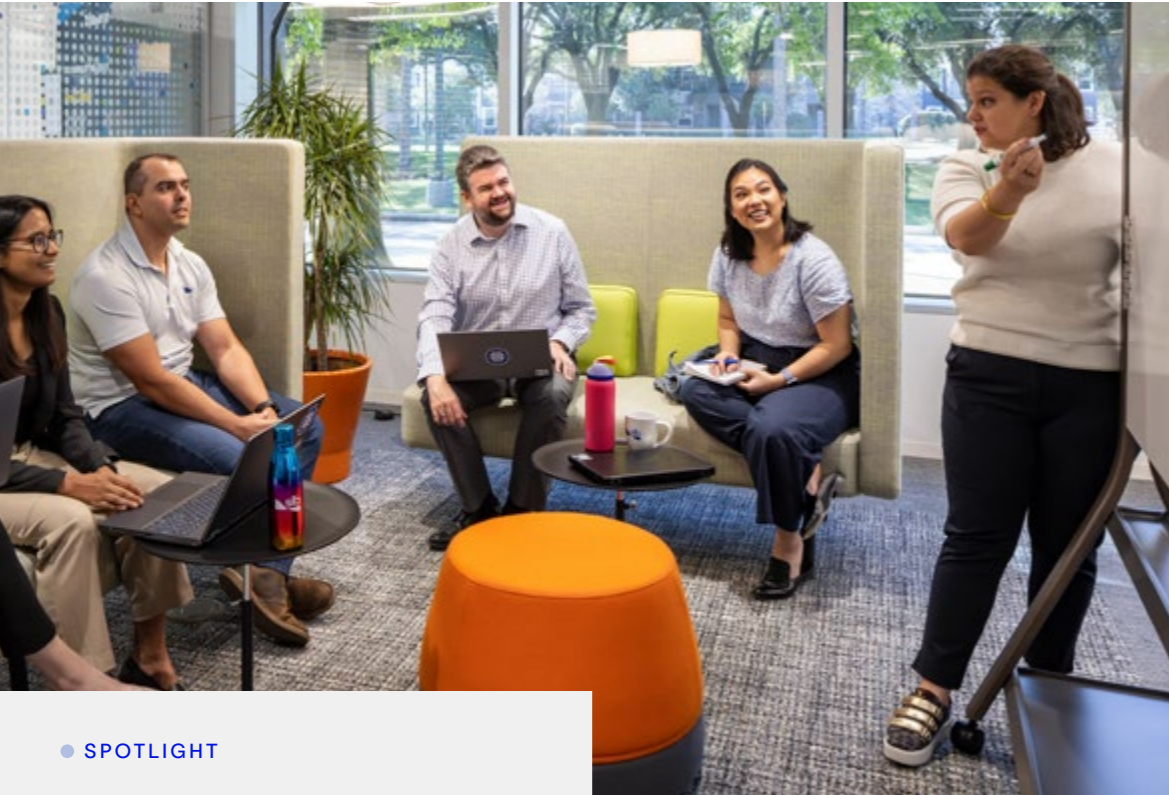

● SPOTLIGHT

Energy Efficiency Initiatives

We achieved a 6% reduction in global energy consumption across our facilities through a series of energy efficiency upgrades, innovative improvements, and comprehensive energy audits.

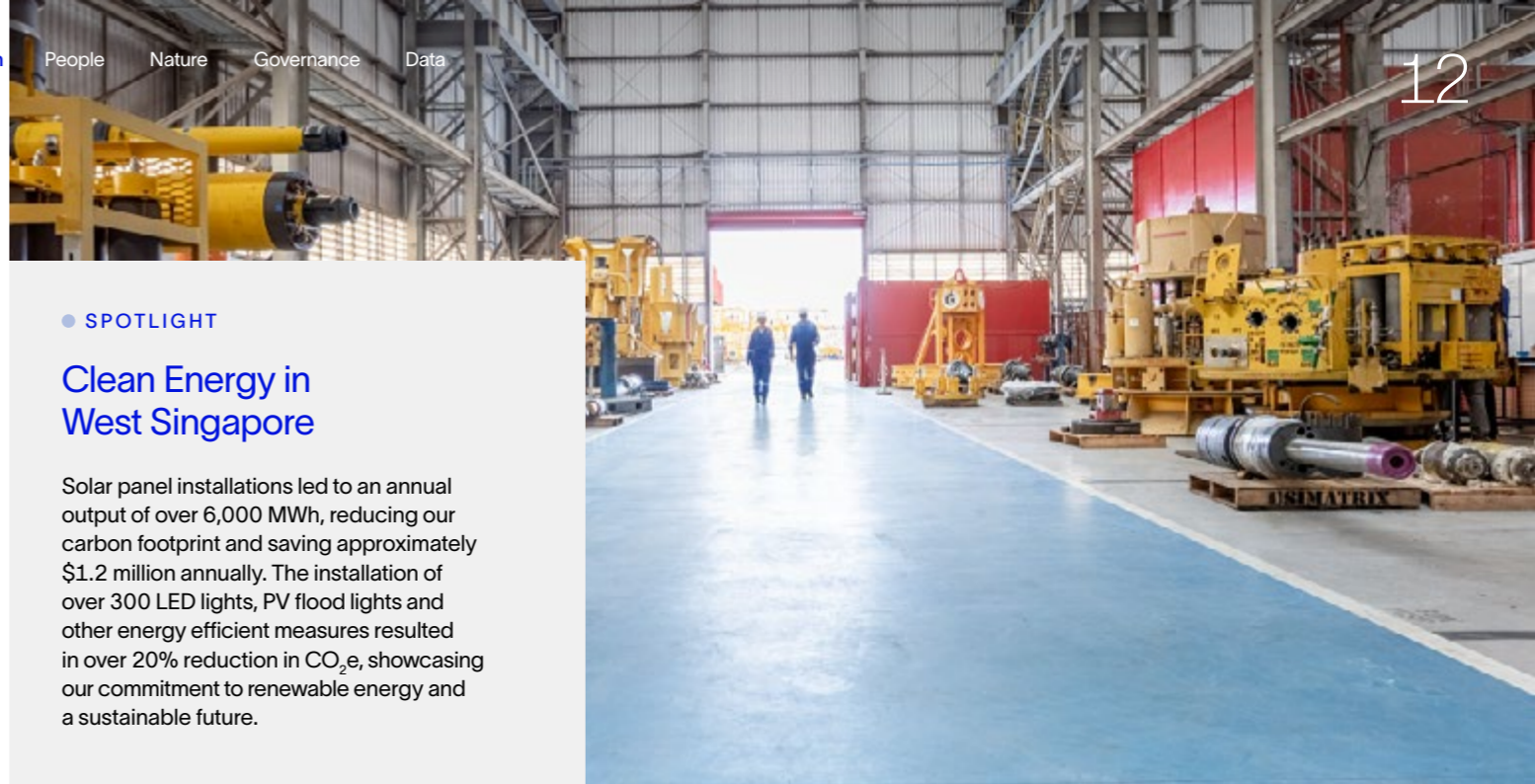

● SPOTLIGHT

Clean Energy in West Singapore

Solar panel installations led to an annual output of over 6,000 MWh, reducing our carbon footprint and saving approximately \$1.2 million annually. The installation of over 300 LED lights, PV flood lights and other energy efficient measures resulted in over 20% reduction in CO₂e, showcasing our commitment to renewable energy and a sustainable future.

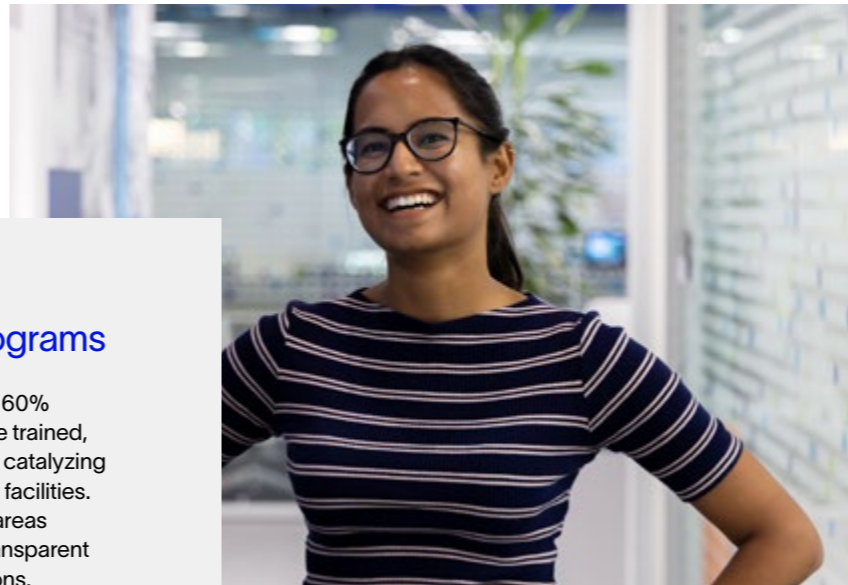

● SPOTLIGHT

Behavioral Change Programs

Driving a shift towards sustainability, 60% of senior-level facility managers were trained, instilling a sustainability mindset and catalyzing notable behavior changes within our facilities. Volunteer committees focus on key areas such as energy management and transparent reporting of greenhouse gas emissions.

● SPOTLIGHT

Canada – Fostering Energy Consciousness

At our St John’s base, we addressed energy management needs by installing smart power meters and fostering an energy conscious culture to optimize usage. The meters provided real-time insight into energy usage, enabling us to take purposeful measures that resulted in a 16% reduction in consumption. This project emphasized our commitment to sustainability through technology, engagement, and behavioral change.

Our Roadmap to Net Zero continued

Scope 3

In line with our emissions KPOs, we extended our emissions scenario planning exercise to include Scope 3 with a focus on business lines with high technology use (Scope 3, categories 1.1 and 1.3) emissions as these make up more than 70% of our Scope 3 footprint baseline. We also advanced our upstream Scope 3 footprint by developing Product Carbon Footprint (PCF) models for key chemical and cement products. These advances will help us better understand our true product footprint, compare emissions between suppliers of the same product, and prioritize decarbonization actions. We're seeing early progress on our Scope 3 journey with a 13%* reduction in our Scope 3 intensity from 2022 to 2023.

In 2023, we developed strategic road maps for our higher carbon emitting products, defining clear and specific milestones in our path to net zero by 2050 with the interim 30% Scope 3 emissions reduction target in by 2030. To navigate this trajectory, we engaged in comprehensive scenario planning. Each business line built a strategy-aligned emissions roadmap with specific emissions reduction actions out to 2030. Internal carbon pricing was used to balance the cost and benefits of decarbonization actions.

We're not just focused on our Scope 3 emissions. We're also dedicated to developing technical solutions for our customers, aiming to decarbonize their operations.



See [Responsible Supply Chain](#) section of the report for more Scope 3 information.

13%*

Scope 3 emissions intensity reduction from 2022.

Technology and Innovation

SLB has consistently led in innovation, marked by a rich history of groundbreaking solutions and industry standards. Operating from 70+ global tech centers, we swiftly deploy advanced technology, ensuring safer, efficient, and sustainable operations.

In 2023, sustainability was deeply ingrained in our product development, with eight key criteria verified at each stage and validated through a lifecycle assessment, especially for products with high Scope 3 emissions.

Life Cycle Analysis (LCA) is the Foundation of our Product Offering to Decarbonize our Customers' Operations.

To measure emissions related to our products and services, we employ an LCA methodology aligned with ISO 14067, embedded in a robust process governance framework. This facilitates systematic estimates of customer-avoided emissions for our Transition Technologies brand. Our methodology was peer reviewed by two academic LCA practitioners from the University College of London and received limited assurance from a third party in accordance with the International Standard on Assurance Engagements ISAE 300 (Revised) to ISO 14067:2018. Our goal is to minimize GHG emissions across the entire lifecycle of related hardware, with products undergoing a cradle-to-grave LCA covering raw material to transport phases.

Applying the LCA during new product development ensures a proactive assessment of the carbon footprint, optimizing products in line with Division emission scenario planning requirements.



SPOTLIGHT

Investing in New Technologies

In 2023, 85% of the increase of our research and development spend was allocated to the development of decarbonization and new energy solutions.



[Learn more here](#)

2023 SCOPE 3 EMISSIONS

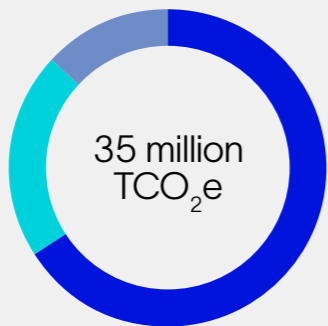

- 66% Technology use
- 21% Purchased goods and services
- 13% Other

Life Cycle Assessment for New Product Development

In 2023, the integration of the Concurrent Lifecycle Management (CLM) sustainability procedure marked a pivotal moment in our Core divisions approach to new product development. The CLM sustainability procedure has four primary objectives:

- 1. Footprint Awareness:** Evaluate the SLB GHG inventory impact to ensure a comprehensive understanding of a product's ecological footprint.
- 2. Footprint Minimization:** Implement measures to minimize a product's ecological impact throughout its entire life cycle.
- 3. Comparative Impact Analysis:** Verify that new products have an environmental impact no worse than their predecessors, emphasizing a commitment to continuous improvement.
- 4. Threshold Review:** Subject products with an impact threshold (metric tons/year CO₂e) enter into a specialized review, aligning them with Division Emission Scenario Planning.

Decarbonizing Customer Operations



Launched at the same time as our net zero commitment, our Transition Technologies portfolio now comprises 34 products and services across the upstream and midstream value chains.

Each technology can quantifiably and meaningfully help customers avoid emissions compared to the industry standard alternative. In 2023, we estimated that the portfolio helped our customers avoid more than 830,000 metric tons of CO₂e in GHG emissions. The portfolio continues to grow as we further embed sustainability into our research and development process and refine our understanding of key needle movers to reduce emissions in oil and gas operations. Building on our net zero commitment, we're evolving our capability to decarbonize our customers' operations and can quantifiably impact their emissions today.

Focusing on the immediate challenge of methane and routine flaring, SLB End-to-end Emissions Solutions™ (SEES) offers a holistic solution to reduce these sources of emissions through a plan-measure-act analysis and emissions reductions with a bespoke digital platform to enable in-house technologies, and technology partnerships.

 [Learn more here](#)

>\$1B

in revenue generated by the Transition Technologies portfolio.

34

products and services to support our customers in decarbonizing their operations.

>830,000

metric tons avoided customer CO₂e emissions.

Decarbonizing Customer Operations continued

Transition Technologies

The Transition Technologies portfolio includes 34 products and services from across SLB's Core divisions. Each of these technologies can quantifiably and meaningfully help customers avoid emissions compared to the industry standard alternative, impacting both our customers' operational emissions as well as our own Scope 3 emissions. In 2023, we estimated that the portfolio helped our customers avoid more than 830,000 metric tons of CO₂e in GHG emissions, while generating more than \$1 billion in revenue. The portfolio continues to grow as we further embed sustainability into our research and development process and continue to refine our understanding of key needle movers to reduce emissions in oil and gas operations.



Methane LiDAR Camera
Methane monitoring in nearly all conditions. [Learn more here](#)



SLB End-to-end Emissions Solutions™ (SEES)

Building on our net zero commitment, we're evolving our capability to decarbonize our customers' operations and can quantifiably impact their emissions today. Focusing on the pressing industry challenge of reducing methane and routine flaring, SLB SEES offers a holistic solution to reduce these sources of emissions through a plan-measure-act analysis and emissions reductions with a bespoke digital platform to enable in-house technologies, and technology partnerships.

We focus our customer decarbonization efforts in three key challenges of the oil and gas value chain: eliminate methane and flaring emissions, decarbonize drilling and completions, and decarbonize production.

Eliminate Methane and Flaring Emissions

Direct methane and flaring represent some of the largest sources of GHG emissions in the oil and gas industry and offer a compelling opportunity not just to decarbonize, but also to make use of energy that would otherwise be wasted.

Vented methane from oil and gas operations is estimated to equate to around 1.5 gigatons CO₂e per year, with natural gas-powered pneumatic controllers still representing a significant portion of this total. Vx Spectra™ multiphase flowmeters are a recognized technology for reducing the number of separators and related pneumatic controllers needed for well production metering. Compared directly to using separators, Vx Spectra can reduce operational GHG emissions by over 99%. At pad level, where some separators are still needed for production phase separation, Vx Spectra flowmeters have enabled emissions reductions of up to 75% compared to a separator-only setup.

In 2023, SEES launched two new sensors to the market, complementing our digital methane platform, technology partnerships, and consultancy capabilities. The methane point instrument is a plug-and-play continuous measurement device that, when installed as an array on a site perimeter, can detect leaks as small as 0.4 kilograms per hour within an accuracy of 6 meters. The methane light detection and ranging (LiDAR) camera uses quantum technology to create an image which enables the user to clearly identify the beginning of the methane plume, identify the emission source, and quantify the leak rate from sources as low as 0.4 kilograms per hour at a distance up to 200 meters. These technologies allow better targeting of remedial actions, such as replacing a leaking valve. To help with the latter, SLB's Low-E valves continue to offer an industry-leading range of ISO and API certified options.

SLB's Transition Technologies portfolio includes products and services that can reduce or eliminate non-routine flaring, such as Ora™ deep transient testing and production express zero flaring, along with technologies to maximize burning efficiency when flaring cannot be avoided. These are some of the most impactful technologies in the portfolio; in 2023, we estimated they helped our customers avoid more than 500,000 metric tons of CO₂e by eliminating flaring.



Vx Spectra™
Surface Multiphase Flowmeter
[Learn more here](#)

For routine flaring, SEES gas value consulting service helps customers pinpoint the right combination of technologies to eliminate routine flaring and potentially monetize excess gas, considering geological, market, and infrastructure factors for their current flaring sites.

Detect and visualize methane leaks as low as

0.4 KG/HR

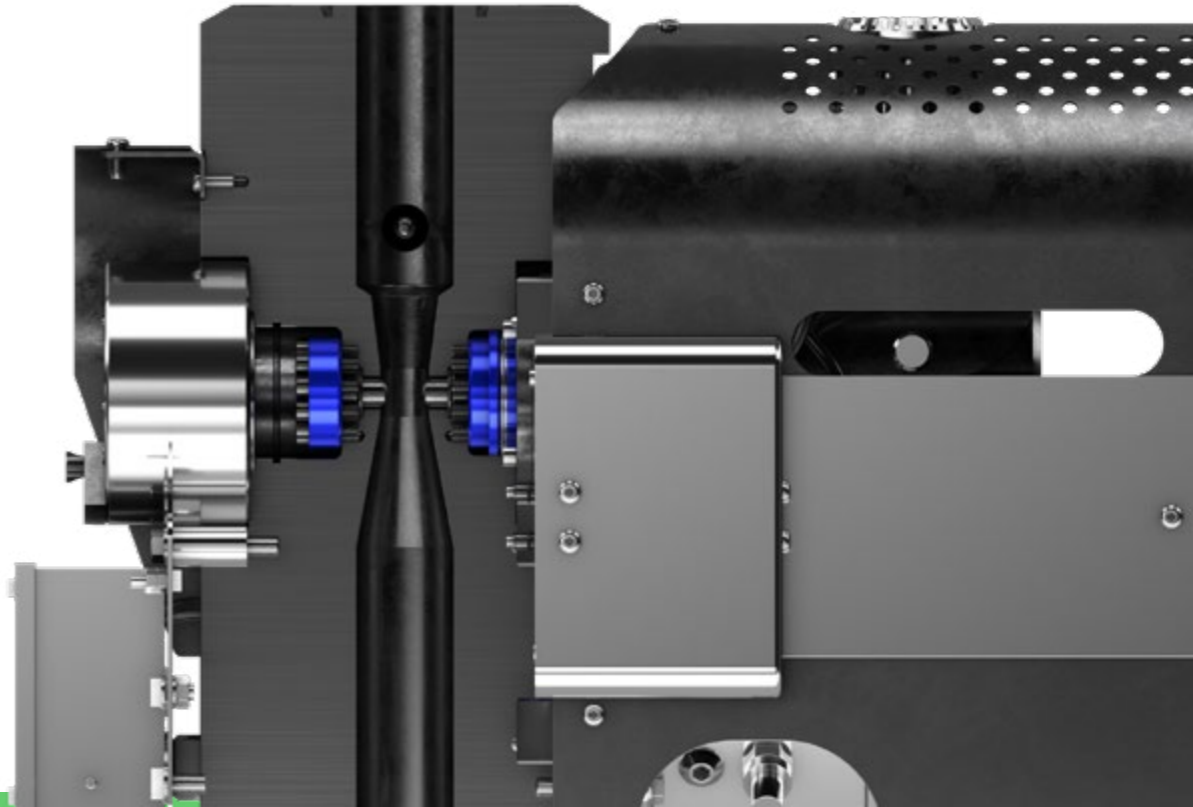

Decarbonizing Customer Operations continued

Decarbonize Drilling & Completions

Reducing the carbon footprint of new well infrastructure is the first step in driving down carbon emissions per barrel over the operating life of a well. SLB's Transition Technologies help operators achieve this by reducing embodied carbon in consumables, improving the efficiency of drilling and completions, and minimizing the footprint of waste transport and treatment.

Reducing Embodied Carbon in Consumables

Based upon historical analysis of drilling performance and fluid losses, we've shown that aqueous drilling fluid systems such as KLA-Shield™, Ultradril™ and Hydraglyde™ reduce extraction, manufacturing, and transportation-related emissions compared to similar-performing oil-based systems. In offshore environments, the average reduction achieved by Ultradril was **46 metric tons of CO₂e, or 70%**, compared to a similar-performing oil-based system in a 12.25 inch hole section.

For cementing operations, our new EcoSHIELD™ geopolymer cement solution was launched in 2023. It eliminates the use of portland cement for cementing operations, reducing embodied CO₂ by up to **85%**. Once fully deployed, the EcoSHIELD system has the potential to avoid up to **5 million tons of CO₂e** emissions annually. In 2023, we estimate EcoSHIELD helped our customers avoid more than 800 metric tons of embodied CO₂e emissions.

Improving Efficiency in Drilling and Completions

Because hydrocarbons are often found in remote locations, without permanent access to electricity from a utility grid, drilling operators rely on power from generators. To address rig power efficiency, we continued to evolve our Intelligent Power Management 1.0™ system, which combines generator management software with battery energy storage to reduce rig fuel consumption and reduce emissions. During 2023, on an active land rig in the United States, we enabled over 1,200 metric tons of CO₂e in avoided emissions and showed continuously improving efficiency.

On the completions side, HiWAY™ Flow-Channel Fracturing Technique continued to help our customers reduce emissions in their stimulation operations. Compared to conventional fracturing techniques, HiWAY is estimated to have helped our customers avoid more than 14,000 metric tons of CO₂e in embodied carbon alone and can enable up to a 30% reduction in fresh water consumption.

Minimizing the Footprint of Waste Transport and Treatment

In 2023, our Envirounit™ service helped avoid more than **13,000 metric tons of CO₂e** in waste treatment-related emissions by avoiding trucking waste water offsite. Additionally, it can reduce customer waste streams by up to 95% and enables onsite discharge of clean and fully compliant water.

HiWAY can enable reduction in fresh water consumption by up to

30%

and helped customers avoid

>14,000 TCO₂e



Decarbonize Production

We aim to reduce emissions in production operations by taking actions as near to the reservoirs, as early as possible in the process chain, and with field-proven solutions.

One of the most power- and emissions-intensive activities in production is lifting hydrocarbons from reservoirs, and this activity is addressed by multiple Transition Technologies. In the offshore environment, subsea boosting systems are estimated to have helped avoid over **30,000 metric tons of CO₂e** compared to the more traditional technique of gas lift. On land, ultra-efficient REDA™ Maximus EON and electric submersible pump (ESP) Permanent Magnet™ motors are estimated to have also helped avoid more than **45,000 metric tons of CO₂e** in electricity consumption-related emissions compared to traditional ESP systems.

Operational efficiency in production can also be addressed by controlling what fluids flow into the well, and minimizing the volume of unwanted fluids that need to be pumped or compressed. In Europe, we helped a customer with a produced water process retrofit package and completions strategies for an upcoming development. By pivoting towards taking actions to control inflow at the reservoir sand surface, net oil recovery improved by 7%, produced water was reduced by 24%, and gas lift gas volumes were reduced by more than 850,000 cubic meters.

Taking actions at the reservoir level can also complement process-efficiency-focused technologies, such as PureMEG™ with Mechanical Vapour™ recovery, Thiopaq™ O&G biodesulfurization systems, and Natco Dual™ Frequency electrostatic systems. By installing a water sensor on a subsea tree, SLB helped a deepwater operator optimize monoethylene glycol (MEG) injection to mitigate hydrate formation, minimize emissions intensive MEG regeneration, and maximize production. By minimizing the turndown ratio of the low-pressure steam boiler used for MEG reclamation – the second largest fuel gas consumer at the central processing facility – the operator achieved greater than **40% reduction in fuel gas emissions and increased commercial gas volume.**



Investing in New Energy and Transition Opportunities

Scaling

New Energy Systems

In 2023, we focused on scaling new energy systems and industry decarbonization. Collaboration is essential for accelerating the energy transition. From tapping energy sources beneath our feet to storing carbon underground, our scientific expertise and experience drive our tech-oriented approach for advancing towards sustainable global impact.

From Local to Global: Scaling Sustainable Solutions

As the world evolves its pledges for a net zero future, we are advancing our solutions for a material impact on the decarbonization of large industrial sectors. Our strategy is to leverage technology and a global deployment platform to help a range of industries – from those with highly energy-intensive operations and hard-to-abate emissions to those related to clean energy generation and usage efficiency. Industrial sectors such as steel, cement, petrochemicals, mining, and power are looking for innovative, high-impact, and scalable solutions to accelerate their journey to a low-carbon future. Our focus is consistent with their ambitions for decarbonization and clean energy solutions at scale.



[Learn more here](#)



Geothermal Field in Northern California
Bringing sustainable energy to businesses
and communities through our geothermal
consulting services.



Investing in New Energy and Transition Opportunities *continued*

Next-Gen Carbon Solutions: Capturing, Storing, and Innovating

Carbon Capture and Storage (CCS) momentum continues to grow as a vital part of our collective effort to combat climate change. Capturing CO₂ before it enters the atmosphere, and then either using it beneficially or storing it safely and permanently underground, demands advanced technology and expertise for a reliable, economical, and sustainable CCS project. We've expanded our partnerships to accelerate the development of emerging carbon capture technologies.

This includes an agreement to co-develop and scale TDA Research Inc's emerging sorbent carbon capture technology, which has the potential to significantly reduce capital and operating costs by minimizing equipment size and footprint, simplifying related process equipment, and cutting energy requirements.

This new partnership adds to our portfolio of cutting-edge carbon capture technologies, focusing on decreasing the carbon capture expenses that typically comprise 50-70% of a CCS project's total cost.

Furthermore, we've launched two innovative carbon storage solutions. [The Carbon Storage Screening and Ranking Solution](#) utilizes both technical and non-technical data to provide a comprehensive assessment of storage site capacity and economic viability, while pinpointing potential risks. After site selection, our novel [Carbon Storage Evaluation Solution](#), complete with a measurement, monitoring, and verification plan, ensures the long-term reliability and sustainability of a carbon storage project. These solutions offer a pragmatic, science-driven approach to deliver reliable, cost-effective, and sustainable carbon storage outcomes.



[Learn more here](#)

CARBON STORAGE SCREENING AND RANKING SOLUTION

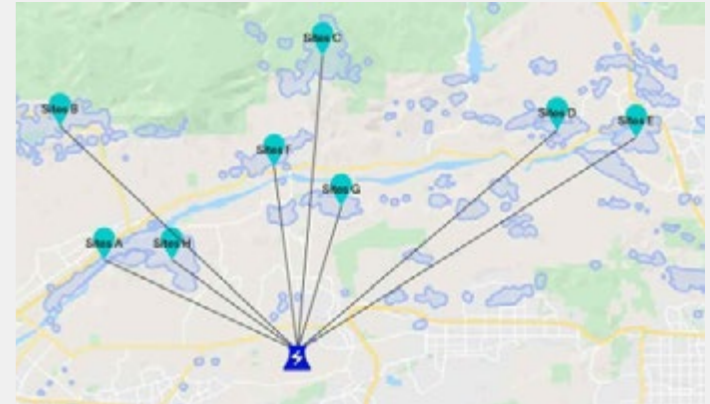

CARBON STORAGE EVALUATION SOLUTION

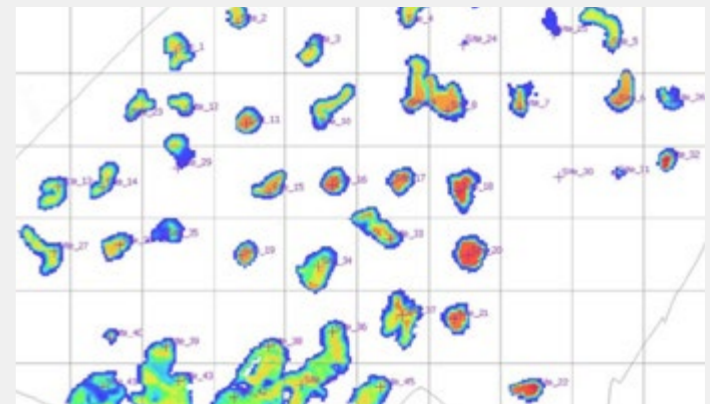

Our experts combine advanced digital technologies with hands-on experience gained from screening numerous potential carbon storage sites. This allows us to identify the ideal fit for our customers' specific needs. Following that, we conduct a precise evaluation to uncover the true potential of a site for carbon storage.



Investing in New Energy and Transition Opportunities continued

Decades of Geothermal Expertise: Reducing Carbon Footprints

In a recent Global Geothermal report, the International Renewable Energy Agency confirmed that, in the coming years, the accelerated deployment of geothermal energy will be driven by advancements in geothermal technologies, cross-industry collaborations between geothermal and related sectors, and the increasing deployment of geothermal for heating and cooling applications.

We are well-acquainted with the geothermal industry. With 50 years of experience in the industry, we possess a profound understanding of the Earth's subsurface, have consistently innovated technology, and have provided valuable insights to the geothermal industry. We harness this expertise to offer geothermal solutions that are cost-effective, local, and dependable, while maintaining minimal surface footprints.

In deep geothermal wells, our Reda Thermal™ power-efficient geothermal ESP is designed to withstand high downhole temperatures. This allowed a Turkish geothermal field operator to boost sustainable energy generation. The Reda Thermal ESP installation has greatly outperformed third-party geothermal ESP run life and has enhanced production by over 55%. Given the ESP's low power consumption of 0.4 MW, this translates to a net increase of 1.7 MW in geothermal power provided to the electricity grid.

According to the World Economic Forum, 15% of global carbon emissions – equivalent to roughly 6 gigatons of CO₂e annually – stem from heating and cooling buildings. This is comparable to the impact of around 1.3 billion gasoline-powered cars, a figure that almost surpasses the current number of cars globally. Geoenergy solutions, when implemented on a large scale, can significantly diminish this environmental impact. Our Celsius Energy™ solution has completed five installations in France and begun operations in both the United Kingdom and the United States. Last winter, Celsius Energy finalized an installation for the Clamart-based Groupement Optic 2000, a premier French eyewear brand. This solution now manages the heating and cooling of the company's 12,000-square-meter main office and workshop and is projected to reduce the facility's CO₂e emissions by more than 70%.



15%

of global carbon emissions come from heating and cooling buildings



[Learn more here](#)

Pioneering Sustainable Lithium Production

In early 2023, we began deploying our sustainable lithium demonstration project in Clayton Valley, Nevada. The SLB sustainable lithium production technology integrates direct lithium extraction, concentration, and conversion to battery-grade material, creating a new approach of efficiency and sustainability for lithium production from brine. As we finalize the pilot plant demonstration to validate the technology at scale, we're progressing in using all the learnings of the past years evaluating subsurface brine resources, using our extensive oil and gas subsurface expertise, and industry-leading digital technology to create solutions to maximize the critical minerals production from the subsurface brine resources. These solutions support advanced subsurface characterization, reinjection, and simulation, ensuring robust optimization of both subsurface and surface systems for economical and sustainable natural resource management for more sustainable lithium production. We have been helping lithium asset owners assess, evaluate, and plan their resource management. This innovative subsurface management approach will aid sustainable lithium production in existing and new regions worldwide. A prime example is in Canada, where we support [LithiumBank Resources Corp.](#) in their detailed subsurface reservoir modeling of the Leduc and Swan Hills Formations at the Park Place Project. This study aims to bolster confidence in future engineering and production designs, as well as provide backing for an imminent resource estimation.



[Learn more here](#)



The demonstration project in Clayton Valley aims to showcase the proof of concept for sustainable technology production, using only 15% of the water, reducing emissions by between 60% and 80%, and utilizing 7% of the land compared to current practices.

Investing in New Energy and Transition Opportunities *continued*

From Demonstration to Deployment: Advancing Renewable Storage Solutions

A key strategy to decarbonize is electrification. In the context of electricity generation, this means a transition to renewable energy sources that will eventually dominate our power systems. Given the intermittent nature of renewables, ensuring uninterrupted energy delivery where and when needed becomes a challenge. Alternatives to lithium-ion energy storage systems present an opportunity to address energy security, mitigate safety hazards, and maximize energy efficiency.

Through our partnerships, we support early-stage differentiated technology development, and contribute with advanced science, engineering capabilities, digital expertise, and an unmatched global footprint for the technology industrialization. We help validate technology performance and test use cases. For this, the initial pilot projects for these technologies are crucial. Within electro-chemical storage, we have two fully operational nickel-hydrogen battery energy storage system pilots in our facilities in the United States and in Germany. SLB undertook system design, integration, software, and deployment optimization. These installations support the de-risking and validation of the testing of a novel battery energy storage system technology in different commercial and industrial use cases.

In diversifying our energy storage portfolio, we have also supported the construction of RayGen's high-tech solar and thermal storage technology demonstration project. We provided project management expertise and domain knowledge for the demonstration project construction and validation of the technology's performance. This project mitigates 10,000 metric tons of CO₂e emissions annually and supplies low-cost renewable electricity around the clock to about 1,000 homes.



[Learn more here](#)



[Raygen's Carwarp solar array.](#)

Bridging Innovation and Adoption through Technology Industrialization

Industrial-level pilot projects represent even more complex cycles of technology de-risking. As low-carbon hydrogen becomes a pivotal component for achieving net zero emissions by 2050, innovations in this area demand substantial investments. A key challenge lies in integrating new technology into demonstration projects without disrupting existing industrial operations.

In 2023, we entered into a global strategic deployment agreement with ZEG, a Norwegian startup. ZEG's technology efficiently produces hydrogen from natural gas with integrated carbon capture, targeting to capture CO₂ at a rate of over 95%. Scaling this technology to an industrial level necessitates collaborative efforts in engineering, project design, and operations management. SLB's expertise, coupled with our global network of engineering and manufacturing, will bolster the subsequent phases of technology demonstrations, ensuring de-risking and validation of various use cases.

In the realm of clean hydrogen production using electrolysis, our joint venture, Genvia™, unveiled its inaugural technology stack pilot line at the SLB technology center in Béziers, France. The strategic co-location of Genvia and SLB's advanced engineering and manufacturing centers expedited the pilot line's development, fostering a seamless transfer of technology industrialization expertise among the teams.



[Genvia Technology Clean hydrogen production technology. Learn more here](#)

The technology, conceived by Genvia – a joint venture among SLB, the French Alternative Energies and Atomic Energy Commission (CEA), and other partners – aims to maximize electrical efficiency by supercharging the electrolyzer with waste industrial heat's thermal energy. This approach drastically cuts down the electricity required per kilogram of hydrogen, paving the way for affordable, carbon-free hydrogen production. This innovation holds promise for broader applications in industrial decarbonization and beyond. Genvia's pilot line in Béziers is set to fast-track the production of electrolyzers for internal assessments, with an aim to roll out its pioneering demonstration system for the steel industry leader, ArcelorMittal, by 2025.



People

Our exceptional and diverse people are the pulse and spirit of who we are. We strive to advance social and economic conditions in host countries and communities; respect human rights in our operations, business relationships, and supply chain; and promote diversity, equal opportunity, health, wellbeing, and social inclusion in the workplace and across our value chain.

Identifying and managing positive and negative business impacts on people, and maintaining high ethical standards are fundamental to our sustainability efforts. We are committed to putting safety, security, and the wellbeing of our people at the center of everything we do, so that host countries, communities, and the energy industry can all prosper on a lasting basis.

By promoting inclusive socio-economic development, we look to accelerate a [just energy transition](#) and promote sustainable development in line with our business growth.



2023 Highlights:

52

SLB facilities underwent human rights due diligence.

15%

Increase in investment for learning and development.

30%

Women in executive leadership team.

Creating In-Country Value

In 2023, our focus was on delivering innovative, scalable, and replicable projects globally in alignment with local sustainable development priorities and aimed at creating positive outcomes for the communities where we operate.



Sustainability Impact Awards

Capital allocation plays an important role in helping SLB meet our sustainability commitments and drive in-country value through community and business investment. SLB's Sustainability Impact Awards, launched in 2022, allocate capital to local teams around the globe to design, select, and deliver high-impact, innovative, scalable, and replicable sustainability projects. Through this program we champion projects that have a sustainable impact in our operations and facilities, and in the communities where we work and live – now and in the future. The awards enable our local teams around the globe to implement projects that tackle local challenges for a net zero, nature positive, and more equitable future.



● SPOTLIGHT

Ecuador: More than Meets the Eye

Building on a successful track record of two decades of partnerships and investments that improve the socioeconomic development of the Amazon region, our Ecuador team combined their internal investments with the capital allocation from the Sustainability Impact Awards to deliver high impact sustainable projects that will continue to improve lives well into the future.

Creating In-Country Value continued

Investing in People and Biodiversity

Our Ecuador team successfully implemented a Sustainability Impact Awards project in partnership with the Polytechnic University of Chimborazo (ESPOCH), the only higher education institution with a presence in the Amazon region of Orellana Province in Ecuador. The inauguration of the “La Belleza” Biotic Research and Interpretation Center represents a milestone in educational, environmental, and livelihood opportunities for the region and the country. The project included the construction of laboratories, greenhouses, ecological trails, staff facilities, and a conference hall in coordination with faculty and staff.

The impacts are:

- Biodiversity and environmental stewardship: the center will produce seedlings for reforestation of intervened areas with native species, fostering biodiversity and providing business opportunities for the institution and surrounding communities.
- Research: peer-reviewed publications will be generated combining ancient indigenous knowledge from the Amazon region with rigorous scientific research. This will lead to more effective environmental impacts and opportunities to develop new solutions and business opportunities.
- Education and tourism: besides enabling students to pursue careers in eco-tourism, environmental, and natural sciences, the center will be used to educate surrounding schools and communities. This will include guided tours of the new ecological trails to foster a culture of sustainability and biodiversity conservation.

Investing in STEM Education

The SEED program has been active in Ecuador for 20 years, benefiting over 18,000 students and 1,000 teachers providing access to computer labs, connectivity, rich and engaging learning experiences in science, technology, engineering, and mathematics, as well as sustainable development topics.



Our local team also invested in the following community impacts:

Local Entrepreneurship

ASOPAME, a local association comprised of 30 members of the Quichua peoples in El Edén, Ecuador, received technical training, equipment, and refurbishment of the premises where two ventures operate. We supported nine local entrepreneurs to participate in fairs, as well as the Women Economic Forum Ecuador.

Education

- Added three more schools in the Amazon region to the SEED program, providing access to computer labs, connectivity, engaging STEM, and sustainable development learning opportunities to over 1,200 students and more than 50 teachers
- 28 STEM and HSE-for-youth and local community trainings, benefiting more than 2,300 participants
- Last mile (fiber-optic) internet connectivity for ten rural schools benefiting more than 3,400 students and teachers, as well as inhabitants of those communities
- Inauguration of Taracoa Training Center, benefiting more than 3,100 inhabitants of the parish

Environment

- Eco-sustainability awards recognizing contractors for their sustainability projects
 - Four reforestation campaigns in Orellana and Sucumbíos provinces, planting more than 1,500 trees
- ### Health
- Six health community brigades, providing more than 6,400 health services
 - Nutritional program benefiting more than 650 school-students and parents in rural areas
 - Support for clean water plant infrastructure benefiting the community of San Pedro
 - Sponsorship of the local committee of the paralympics Orellana-Province team

Additional Activity Focus

- Canada – Indigenous peoples
- Turkey and Argentina – STEM education
- Brazil and Egypt – People with disabilities
- Uganda – Community access to water
- India – STEM and circularity
- Oman and Algeria – Women inclusion



[Learn more here](#)

Respecting Human Rights

Conducting business in a manner that preserves and respects human dignity is fundamental to the sustainable operation of our business.

By respecting human rights, we aim to avoid harm, and we have the potential to contribute to more inclusive societies embraced by the [UN Sustainable Development Goals](#).

In 2023, we strengthened our internal assessment processes by scaling our human rights due diligence programs in our facilities and our supply chain. We also conducted an external assessment, undertaking a comprehensive third-party assessment of our human rights program to align efforts where we can have the most significant impact.



● SPOTLIGHT

Petrobras

In 2023, SLB was recognized by Petrobras with a Best Supplier Award for human rights for the second consecutive year.

52

SLB facilities underwent human rights due diligence, resulting in improvements to working conditions for employees and contractors.

>11,500

labor rights training modules completed by employees in our e-learning platform.

More than

2,400

SLB employees and contractors certified as part of the [Truckers Against Trafficking](#) training program.

Facilities in Nigeria and Italy scored

100%

when benchmarked against a third-party standard and were found to be fully compliant.

In 2023,

462

suppliers underwent human rights due diligence via self-assessments or SLB audits.

Respecting Human Rights continued

● SPOTLIGHT

External Assessment

Advancing our Human Rights Program

A comprehensive assessment of our human rights programs was conducted by two reputable third parties in 2023, resulting in the following observations:

- SLB has a strong governance foundation. We ensure consistent requirements across the organization through centrally promulgated policies with cross-functional implementation. This has been facilitated by dedicated sustainability roles and engagement of external advisors.
- SLB has made a significant investment in due diligence procedures, with a phased, risk-based approach addressing labor rights and worker welfare in our operations and supply chain.
- SLB risk mapping, mitigation, and remediation methodology is aligned with [UNGP](#) and focused on rights holders impact likelihood and severity, prevention, mitigation, and remediation.
- Leveraging our human rights data points and integrating findings to inform potential and/or actual impact and develop a consistent approach to remediation will help us improve our effectiveness and inform our human rights strategy in a rapidly evolving landscape.
- Human rights have also been embedded in existing risk management initiatives, including those in conflict-affected and high-risk areas.



Supply Chain Assessment Impact

Building on the supplier self-assessments done in 2022, we expanded our due diligence in 2023 by completing 462 supplier assessments.

Additionally, in-house suppliers in 52 SLB facilities around the world, underwent assessments of their working conditions, resulting in actions to prevent, mitigate, and remediate negative impacts. The primary opportunity for improvement identified was documentation regarding suppliers' policies, procedures, and processes.

In order to address these and other human rights risks, we continued our dialogue with suppliers through supplier forums and performance reviews, utilizing Ipieca and the Building Responsibly modern slavery training modules to train our suppliers.



[Learn more here](#)



● SPOTLIGHT

Working Conditions

At a facility in Africa, we worked with a community enterprise to integrate checks and controls to document and confirm the ages of all their workforce. In addition to preventing working conditions risks, we included a labor rights module in our new employee safety training for all personnel working at the facility. This included our contractors' workforces and engaged with our onsite subcontractors to build awareness around our grievance, reporting, and remedy channels.

● SPOTLIGHT

Internal Assessments

In 2023, we performed 52 assessments at the facilities mapped as having the highest potential labor rights risks across SLB geographies. With these insights, we were able to identify and remedy working conditions at a local level. This includes improving the processes used to document and manage potential risks such as:

- the oversight of in-house contractor compliance
- fatigue management plans
- checks on recruitment costs
- management training on human rights

Promoting Talent & DEI

Our people are, and will continue to be, at the heart of everything we do. They are exceptional and diverse people who are the pulse and spirit of who we are.



As an integral part of our new cultural framework, each of us contributes to nurturing an inclusive environment where every individual feels empowered to contribute to SLB's success, learn from our differences, and enhance our creativity and performance. In 2023, we elevated inclusion as a key priority across SLB, and progress against this goal is being measured at both local and global levels.

Diversity has always been at the core of SLB's identity. Since our founding in 1926, we've embraced the principle of hiring where we work, fostering a rich cultural diversity that defines us. With nearly 200 nationalities represented in SLB, and nine nationalities among our ten-member executive leadership team, our organization is a tapestry of various cultural backgrounds and perspectives.

Our journey has evolved to celebrate all the ways people differ. We are committed to ensuring that everyone, regardless of their differences, feels included and valued.

SLB Sustainability Upskilling

Population receiving training

Internally developed content (online and/or in person)

Senior Management

→ SLB Executive Sustainability Program

Middle Management and Subject Matter Experts

→ Circular Economy Training
→ Leadership Trainings

Professional and Supervisor

→ Leadership Trainings
→ Fixed-step Learning Programs
→ Taking Climate Action Training
→ SLB Transition Technologies Training
→ Understanding SLB Emissions Training
→ Human Rights Training
→ SLB Water Stewardship Training
→ Enabling Circularity at SLB Training

New Hires

→ Sustainability Community
→ Employee Resource Groups
→ SLB Sustainability Report
→ Internal Sustainability Page
→ OneSLB Introduction Session



Promoting Talent & DEI continued

Learning & Development for Our People

SLB fosters a growth mindset as one of our core behaviors through our comprehensive learning and development offerings. Through our investments in learning and development for our people, we strive to empower employees with the expertise needed for success, and ensure that we support their professional and skills development, while in parallel developing a well equipped and trained talent pipeline for the organization. In 2023, we continued to strengthen our learning and development offerings by increasing our investment in employee learning and development by 15%, with more than 200 dedicated learning professionals supporting the skills development of our 111,000+ workforce.

In 2023, we also focused our online learning offerings around our three strategic focus areas of digital, sustainability, and production. We introduced a multitude of new learning pathways in these areas, which are open to all employees and contribute to fostering a growth mindset focused on reinforcing SLB's key strategic priorities.

We also included an incentivized target for the Human Resources function to promote skills development in these areas. These new online pathways complement our already expansive inventory of nearly 3,600 online learning pathways available to all our employees.

Leadership Culture Training

In order to reinforce our collective behaviors and ensure that we bring our values to life, in 2023, approximately 240 leaders from across SLB – executive leaders to presidents, vice presidents, and their direct teams – started the Living Our Culture Senior Leader Role-modeling Program. This development program spans nine months and consists of evidence-based assessments, advisory sessions, one-on-one debriefs, meeting observations, and workshops. These sessions focus on strengthening the qualities that help create strong role models and impactful leaders, and on sustaining those qualities for the long-term success of our culture evolution.

In 2023, we launched the SLB Executive Sustainability Program in collaboration with Berkeley Executive Education (at the Haas School of Business). This applied program focuses on reducing carbon emissions, safeguarding natural resources, and enhancing business value through sustainability. It incorporates SLB data and examples for practical learning, underscores the significance of ESG data transparency for reporting, and empowers attendees to assess and communicate the impact of climate change on business and society. Participants learned to develop and prioritize actions to advance SLB's sustainability strategy and design a plan for sustainable practices, including emission reduction and engagement in eco-friendly business approaches.



Taking a cross-stakeholder approach to inclusion, we engage all parts of our company at every level. This approach includes:

Global leadership commitment

Our strong and visible global leadership is fully committed to diversity, equity, and inclusion.

Empowering local initiatives

Our various locations are empowered to drive appropriate local inclusion initiatives, ensuring that our commitment is felt and implemented on the ground.

Partnerships and employee resource groups (ERGs)

We collaborate with partners, including ERGs, where individuals with shared interests can connect, fostering a sense of belonging and collaboration.

Individual responsibility

We emphasize the role of each individual in making others feel welcome and valued. Through awareness and compassion, we create an environment where everyone's contributions are recognized and appreciated.



Promoting Talent & DEI continued

Inclusion Index

In 2023, our overall Inclusion Index perception by employees was scored at 74%. This was an increase of three percentage points from 2022. The index considers seven key elements:

- Fair treatment
- Psychological safety
- Integrating differences
- Decision making
- Trust
- Belonging
- Diversity



D&I Council team and employees hired as a part of the initiative for Inclusion of Persons with Disabilities at OS&IT Pune Information Technology Center



Our Journey to Diversity and Inclusion

We are dedicated to creating a fairer, more prosperous world for all by applying the principles and insights from our diversity and inclusion program throughout our entire value chain.

Employee Resource Groups (ERGs)

ERGs play a vital role in building a diverse and inclusive environment. These groups provide a safe space for employee-led conversations, fostering a greater sense of belonging. Additionally, ERGs help improve representation across our company and our communities.



[Learn more here](#)

2023 Women and Pay Gap

With our commitment to support women and pay equity, SLB, again, in 2023 updated our equal pay gap analysis.

2023 WOMEN AND PAY GAP

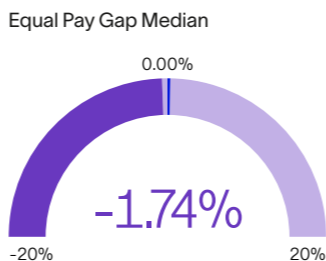
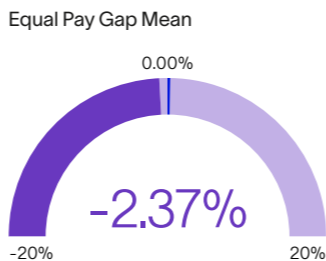

We are on track towards our milestone of women representing 25% of our salaried employees by 2025.

SLB does not make employment decisions, including decisions regarding hiring, promotion and compensation, on the basis of any legally protected characteristic, including nationality, race or gender, but is focused on making opportunities to excel accessible to all. We implement this goal by adhering to employment laws in each of the countries in which we operate.

Promoting Talent & DEI continued

Inclusion in the Community

At SLB, we recognize the transformative power of education in building connections with the communities where we operate. Our commitment to UN SDG 4 drives our investments in quality education, particularly for women and young individuals from underprivileged backgrounds, emphasizing technology and STEM fields. Presently, our educational outreach focuses on three key programs: Faculty For the Future, SEED, and HSE for Youth.

● SPOTLIGHT

Faculty For the Future

Administered by the Schlumberger Foundation, a non-profit organization, this initiative supports women from developing economies in pursuing Ph.D. or post-doctoral studies in STEM subjects at top universities worldwide.

FACULTY FOR THE FUTURE

	2023
New Fellowship Awards	56
Fellowships Renewed	60
Total Fellows and Alumni Since 2004	863
Total Host Universities and Research Institutions Since 2004	333



SEED

In 2023, SLB celebrated the 25th anniversary of SLB Excellence in Education Development (SEED). Since 1998, SEED has been instrumental in providing STEM learning opportunities and establishing STEM-rich learning environments for young people.

SEED

	2023
Participating Teachers	>1,800
SLB Employee Volunteers	>800

SEED WORLDWIDE

>44,000

young people participated

28

countries

>120

SEED events in 2023

HSE for Youth

This program extends support to both young people in the community and SLB employees' children, fostering a better understanding and decision-making related to HSE matters.



Promoting Talent & DEI continued



In 2023, we launched a pilot neurodiversity program with colleagues in finance, IT, and supply chain in Kuala Lumpur. The pilot will help us evaluate our recruiting, onboarding, and training practices to create a more robust process that will be more inclusive in line with SLB culture. The pilot will help us gain insights to allow for broader implementation of the practices enterprise wide.

● SPOTLIGHT

Singapore

In Singapore, we hosted training, workshops, and job shadowing focusing on disability and neurodiversity education. By building our disability and neurodiversity confidence we're ready to welcome a broader range of talent and skills.

Awards

Disability Equality Index

2023 Best Places to Work



[Learn more here](#)

In 2023, SLB earned

#1

2024 Military Friendly Employer ranking in the United States in the largest company category



[Learn more here](#)

LinkedIn Rankings

SLB ranks fifth

as best places to grow your career in France

In Saudi Arabia, SLB ranks 13th of top 15 companies to work for

In Nigeria, SLB ranks 16th for best places to grow your career

SLB recognized among the

top 20

most admired global business services organizations by SSON Research & Analytics



[Learn more here](#)

SLB recognized by Handshake as

top employer for Gen Z careers



[Learn more here](#)

SLB Global Business Services Winner

Malaysia's 100 Leading Graduate Employers 2023 Award in the BPO & Shared Services category

Nature

Our focus is advancing environmental sustainability by minimizing our impact on ecosystems and biodiversity, conserving natural resources, and promoting circularity throughout the lifecycle of our technology.

In 2023, we focused on improving our understanding of SLB's potential impact on nature. We are building our roadmap for the future, currently focused on water stewardship and enabling circularity, assigning clear ownership within our company, and setting future targets.

Nature

2023 Highlights:

100%

capability to measure water consumption in our facilities.

>800

facilities assessed for biodiversity risk.

'Enabling Circularity at SLB' training rolled out.



Safeguarding Biodiversity

SLB’s commitment to safeguarding biodiversity underscores our sustainability efforts, extending throughout our operations, facilities, and local communities.



WWF BIODIVERSITY RISK ASSESSMENT TOOL



In 2023, we embarked on a comprehensive biodiversity risk assessment, utilizing the WWF Biodiversity Risk tool to understand potential impacts on biodiversity. This evaluation examines how our operations and value chain may face physical risk if located in areas where ecosystem services are declining or under pressure. Furthermore, it will strengthen our existing environmental management standard, in line with our commitment to responsible environmental stewardship.

This assessment represents a significant milestone in our commitment to sustainability, guiding us in responsibly managing our environmental footprint and ensuring a sustainable future.

Going forward, our biodiversity focus is on further analyzing the impact and dependencies of our activities and value chain, prioritizing actions based on initial risk assessments.

This begins by assessing our current status and maturity level, evaluating opportunities and risks to define our strategic approach with a focus on mitigation and promoting more sustainable initiatives. By aligning business operations with biodiversity conservation, we can contribute to preserving vital ecosystems and species, and enhancing our sustainability and resilience.



[Learn more here](#)

Safeguarding Biodiversity continued



Biodiversity Protection

Our strategic approach extends to diverse ecosystems, exemplified through our initiatives across the globe. Notably, our commitment to biodiversity protection in the Amazon region of Ecuador represents a core element of our efforts. We recognize the urgent need to combat habitat fragmentation, a primary driver of the ongoing biodiversity crisis in Latin America. As a proactive measure, during road and pipeline construction in Bloque 61, our Biological Specialists maintained canopy bridges to minimize the disruption caused by habitat boundaries. By preserving essential trees for engineering purposes, we successfully created a biological corridor, ensuring the genetic continuity between flora and fauna populations. Our 2022 and 2023 environmental management plans also included relocating more than 30 species to their native habitats.

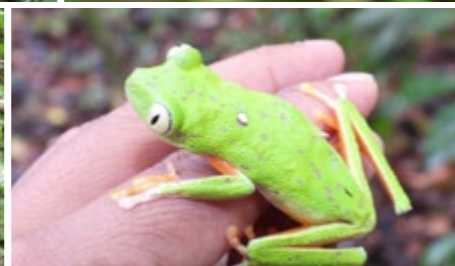
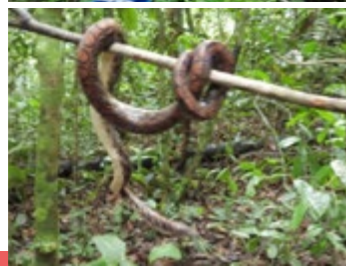
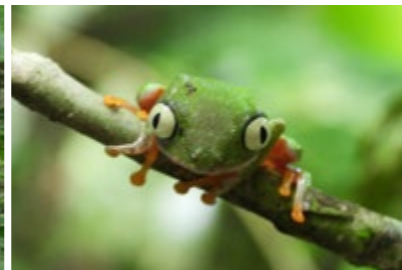

Relocation of species to their native habitat in Bloque 61, Ecuador

Empowering Local Teams

Engaging our employees and their families in global conservation efforts is a cornerstone of our biodiversity protection mission. In Malaysia, our teams collected and recycled 500 kilograms of waste from a local beach. In Mexico, we established a vertical garden at one of our facilities, utilizing air conditioning condensation for irrigation purposes to nurture natural ecosystems. In Romania, over 350 of our employees and their families joined forces to plant 7,000 resilient oak trees, in the Snagov area, selected for their CO₂ absorption capabilities.

In Brazil, our partnership with the Conservation Unit REBIO União involved providing new flora and fauna signaling for an inclusive trail designed for people with disabilities, alongside conducting environmental education activities for local school communities. Our endeavors reflect our unwavering dedication to biodiversity protection, emphasizing both environmental sustainability and community engagement.

Protecting Natural Resources

SLB is deeply committed to safeguarding our planet’s invaluable natural resource: water.

As part of our ongoing dedication to a balanced planet, water stewardship emerged as a cornerstone of our mission in 2023. This year marked a significant turning point as we harnessed our tools and data systems to meticulously track our water footprint and gain a deeper understanding of water risks in the areas where we operate. This crucial step set the foundation for our initiatives aimed at reducing our environmental impact.

Our approach to water stewardship is rooted in three pillars: measure, reduce, and replenish. Our commitment is to measure, reduce, and restore water resources, laying the groundwork for a more sustainable future. Responsible water management is central to our operations. While we have consistently complied with local regulations governing water use, discharge procedures, and treatment, our vision reaches beyond mere compliance. It encompasses a holistic strategy that addresses a wide spectrum of water-related challenges and opportunities within our industry, fortifying our role as leaders in sustainable operations.



[Learn more here](#)

Established total water consumption baseline in 2023

SPOTLIGHT

2023 Water Risk Assessment

From our 2022 water risk assessment, we developed a more in-depth analysis by plotting 840 facilities on the WRI Aqueduct Tool water stress map, which covers over 90 countries where we operate. This assessment revealed that 30% of our facilities are located in regions considered to be at a high to extreme risk of water stress.

2023 WATER RISK ASSESSMENT OF SLB FACILITIES

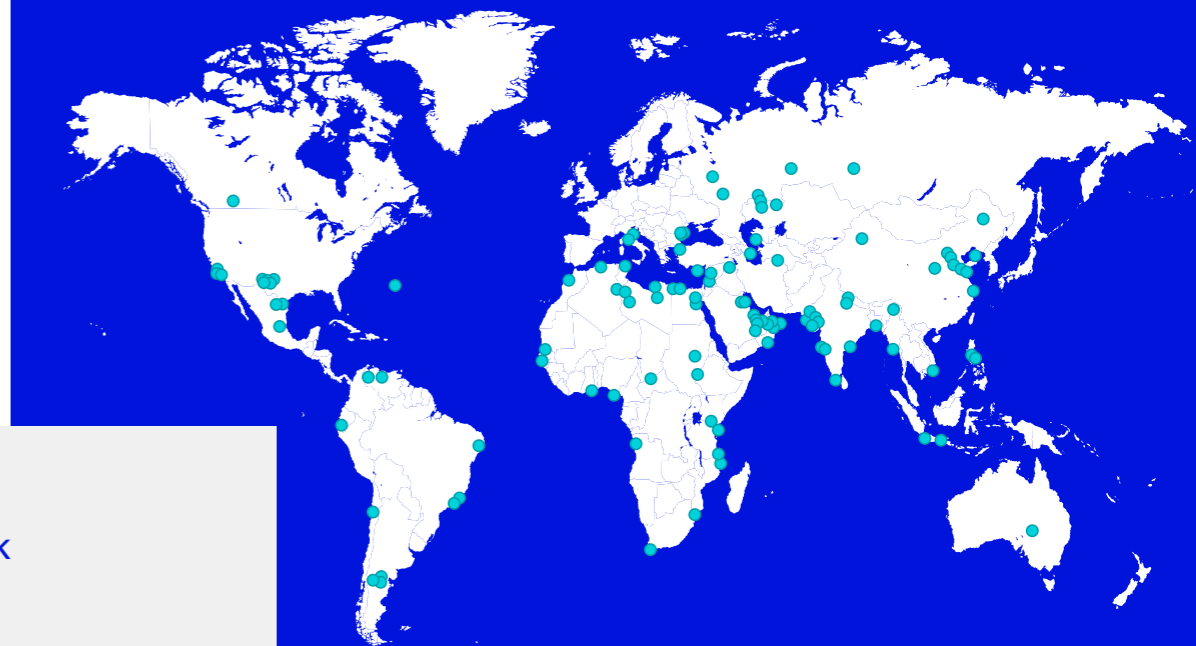

Protecting Natural Resources continued

1. Measure

In 2023, we expanded our efforts in water stewardship to record water usage across our facilities and our operations, spanning maintenance centers, technology hubs, manufacturing sites, offices, and accommodation camps.



FACILITIES CONSUMPTION BY WATER CATEGORY IN 2023

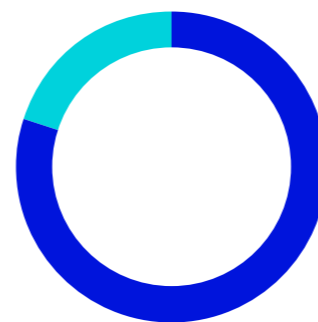

- 80% Fresh water
- 20% Other water Categories¹

1. Other water categories may include: produced water, seawater, brackish water, among others.

Our water stewardship journey expanded by establishing a baseline for our operations in 2023. We have developed an integrated system for enhanced water tracking and monitoring.

We went beyond water consumption recording within our facilities to include all operations to gain deeper insights into the parameters of our daily operations. This highlighted the business lines with higher water consumption, including drilling fluids, cementing, and well stimulation.

To enhance data integrity, we are investing in smart metering for water consumption, targeting facilities in high-water-stressed areas.

>3.7M

cubic meters total water consumption at our facilities in 2023

Protecting Natural Resources continued

2. Reduce

Having established a baseline for water consumption, our next step is to enhance water efficiency and promote water stewardship at our various locations.

In 2023, we launched ten projects under our Sustainability Impact Awards program, dedicated to water conservation, water generation, water treatment, and rainwater harvesting. These initiatives harnessed technology, best practices, and water-saving measures to curtail water usage in a range of processes, encompassing operations, cleaning, and manufacturing. Through these projects and other successful local initiatives, we reduced water consumption by over 250,000 cubic meters.

In Saudi Arabia, our closed-loop system, featuring over 200 wells, stands as a beacon of water sustainability. Through our innovative approach, we've not only drastically reduced water consumption, waste, and CO₂ emissions but have also conserved almost 16,000 cubic meters of water in drilling operations.

In Guyana, we introduced a water recycling system that, within a year, recycled over 840 cubic meters of water. This initiative not only reduced our reliance on local water sources but also significantly lowered our water bills.

In Angola, we implemented a water filtration and recycling system at the washbay, enabling us to reuse wash water and estimated to save 200,000 cubic meters annually. Additionally, at our facility in Qatar, we installed a washbay water recycling system, which is projected to reduce water consumption by 86%.

In Uganda and Gabon, we introduced innovative rainwater harvesting systems that substantially reduces our dependence on traditional water sources. These systems enable us to collect, store, and purify rainwater for various purposes, collectively saving over 2,000 cubic meters of water annually at these facilities.

Our efforts in India centered on water treatment and wastewater recycling, resulting in an annual savings of 10,000 cubic meters of water per facility. Furthermore, we facilitated the construction of rooftop rainwater harvesting systems in local communities, each with a 10,000 cubic meter capacity tank, saving approximately 40,000 cubic meters of water annually in each location.

In Mexico, our commitment to responsible water management involves filtering, treating, and reusing water at our facilities and installing innovative hydropanels to create self-sufficient drinking water systems, with plans to extend these solutions to the communities where we operate.

CLOSED LOOP SYSTEM IN SAUDI ARABIA

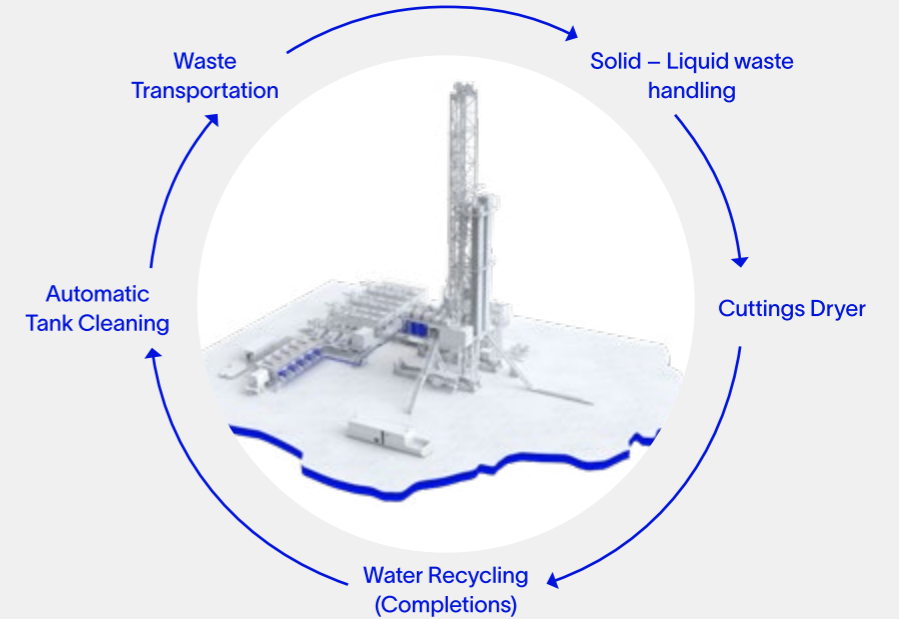

Water saved per Well

130M³

Mud recovered per Well

77M³

Avoided emissions per Well

147TCO₂e

Mud tanker trips saved per Well

11

The "Closed Loop" is a more environmentally friendly combination of processes and systems to handle and minimize the generated volume of waste during drilling operations and to recover/recycle highly valuable drilling fluid or water, up to 30% volume savings with a dryer system, and reusing mud for cost savings. It reduces diesel and water consumption, waste volume, logistics, pit size, site reclamation costs, and CO₂ emissions.



Protecting Natural Resources continued

3. Replenish

Our vision for water replenishment involves collaborating with local communities and stakeholders to support sustainable water use and management initiatives.

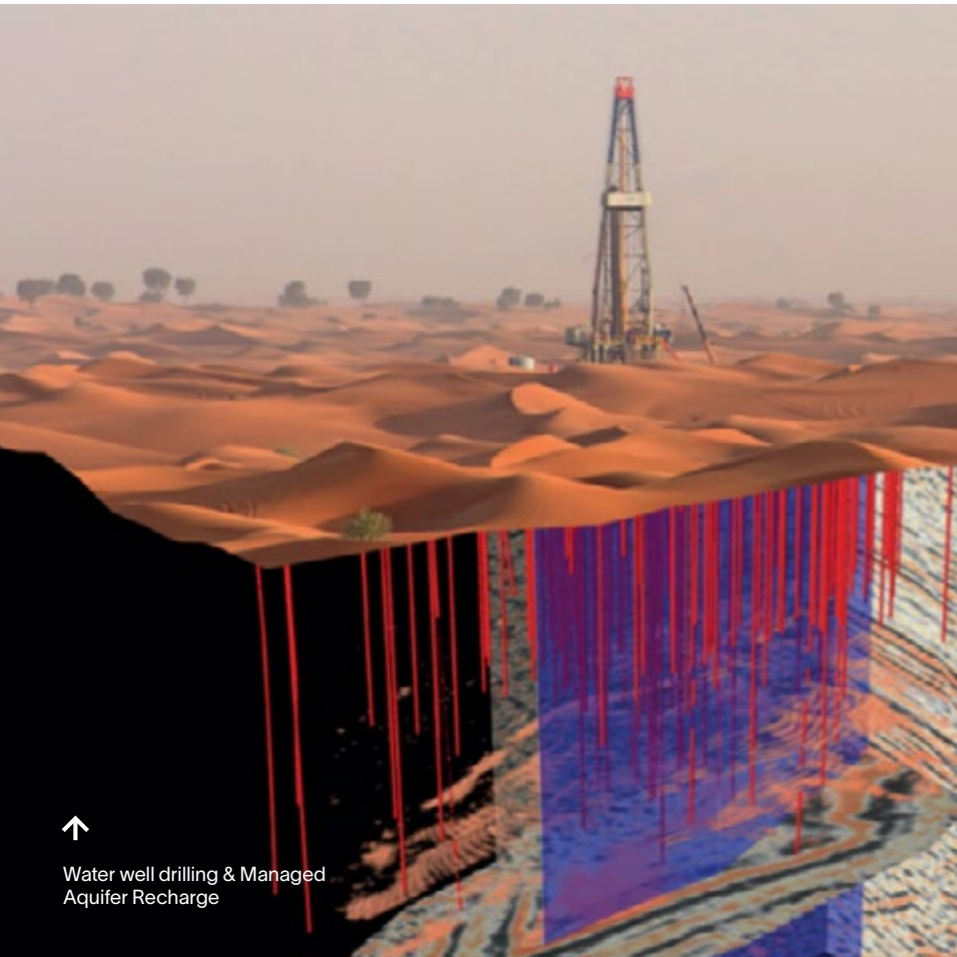

Water well drilling & Managed
Aquifer Recharge

SLB Water Services

In response to Qatar's water scarcity, SLB Water Services, in collaboration with government agencies, introduced a pioneering Managed Aquifer Recharge™ solution involving deep recharge wells that extend 400 meters into the ground. This innovative approach has now become fundamental to Qatar's water management. Each system is licensed by the regulator to handle up to 8,000 cubic meters of treated water daily, contributing to an annual recharge of over 54 million cubic meters of water into the aquifers, leading to an improvement in the quality of groundwater for the receiving aquifer, which is naturally saline, and enhancing water resources for the future.

In Turkmenistan, our initiatives involve installing water filters in three complexes, benefiting local communities and significantly enhancing their quality of life by reducing the risk of water-borne illnesses. In the first half of 2023, we recycled more than 450 cubic meters of water through these projects.

In the Philippines, we collaborate with municipalities to rehabilitate water supply systems for underserved communities. Our current project aims to provide a consistent water supply to communities with limited access to a reliable source of clean water.

Partnerships for water stewardship initiatives have been established to collectively address water challenges in the regions where we operate, reinforcing our commitment to sustainable water management. All these actions collectively counterbalance our water usage through investments in projects involving aquifer management, reverse osmosis, and digital capabilities. By adopting this strategic framework, we are not only reducing water-related risks and environmental impact but also contributing to the preservation and sustainable use of water resources for future generations.

Our water stewardship efforts align with our broader sustainability goals and exemplify our commitment to a more resilient and balanced planet, creating positive and lasting impacts on our environment and communities worldwide.



Enabling Circularity

SLB Circularity for a Sustainable Future

Our circular practices aim to minimize waste, maximize the lifespan of products, and prioritize the efficient use of resources throughout the entire lifecycle. By embracing circularity, SLB contributes to reducing environmental footprint, conserving valuable resources, and mitigating the negative impacts associated with traditional linear production and consumption models. Beyond environmental benefits, circularity enhances our operational efficiency, stimulates innovation in product design and business models, and ultimately drives long-term economic resilience. A commitment to circularity aligns with our broader goal of creating a sustainable and balanced planet.



[Learn more here](#)

Guided by the Circular Economy Principles, we have prepared our road map for Enabling Circularity in SLB to address the challenges of resource depletion and environmental impact. By adopting these principles, we not only reduce the demand for virgin resources but also minimize waste generation through practices such as **5“R” workflow**: reduce, reuse, refurbish, remanufacture and recycle.

Enabling circularity in our organization, when utilizing finite materials, is imperative as it allows us to extract maximum value from limited resources at our disposal, mitigating the environmental impact associated with their extraction and disposal. Adopting circularity fosters resilience by reducing dependence on virgin materials, which may become scarcer or more expensive over time.

Circularity aligns with evolving consumer expectations and regulatory trends, positioning our organization as a responsible steward of resources. In SLB, we have designed our circularity approach in a holistic transformation across several functions in the organization.

CIRCULAR ECONOMY PRINCIPLES

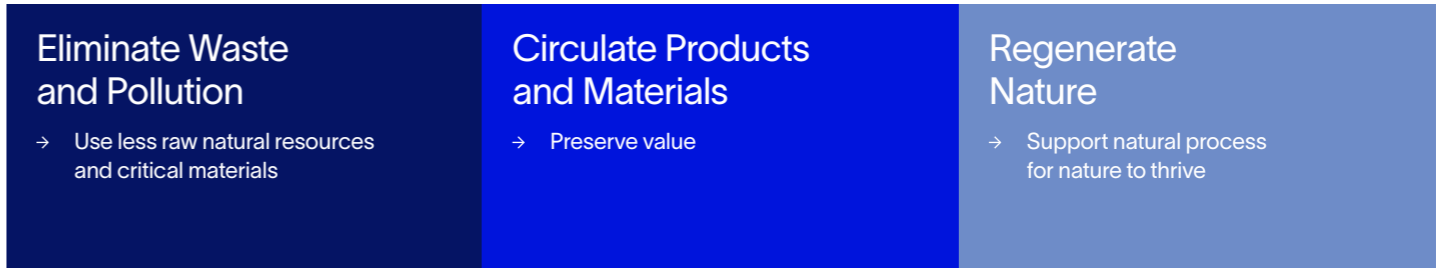

FROM LINEAR TO CIRCULAR

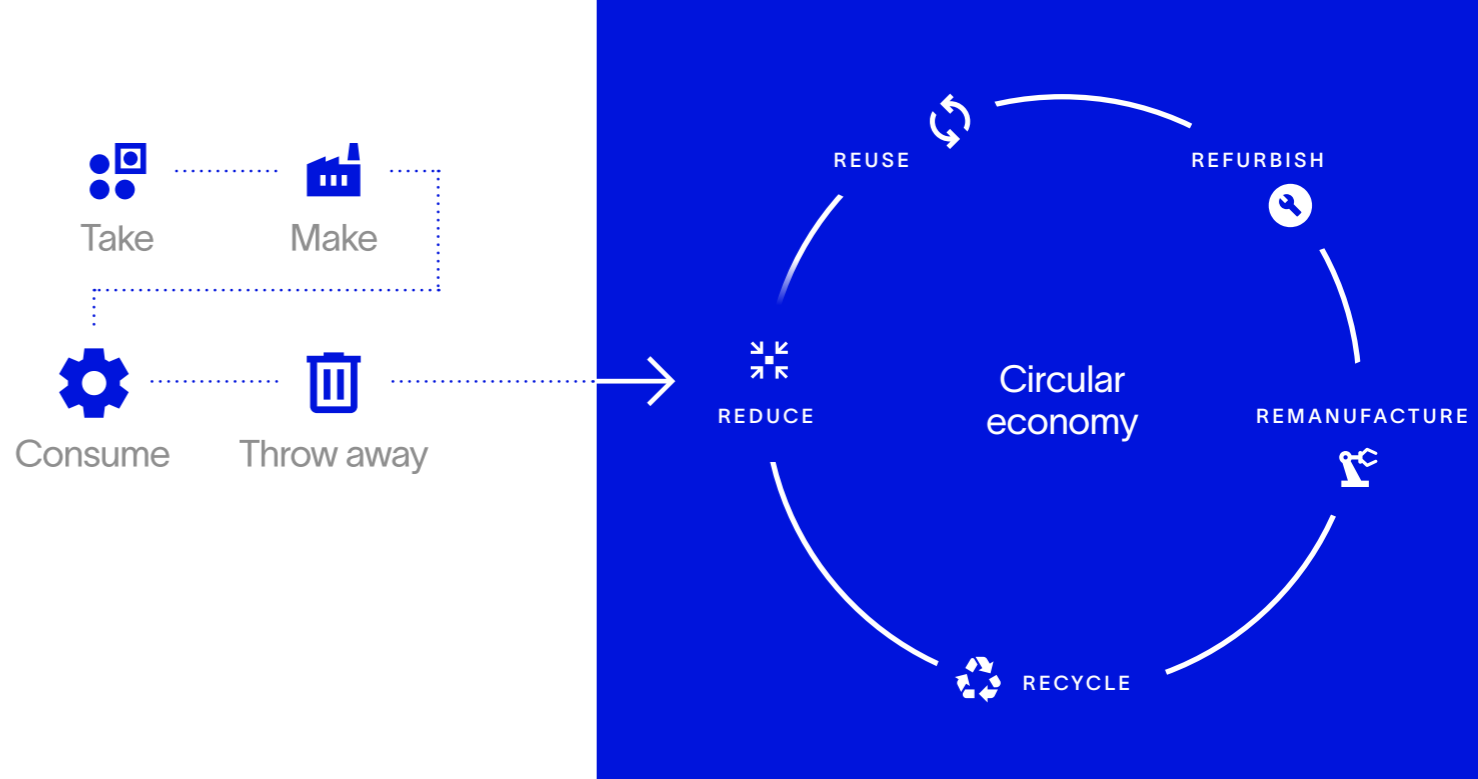

Enabling Circularity continued

Exploring SLB Circularity Loop

Technology and Manufacture

Designing for circularity is a collaborative effort involving our technology teams and insights gathered from maintenance feedback, highlighting the potential for tools to become more modular, facilitating the remanufacturing process.

In 2023, we fostered close collaboration with local vendors, exploring economically viable opportunities to repurpose materials while minimizing transportation needs.

Technology Lifecycle Management (TLM) Maintenance Network

The TLM function oversees the acquisition, maintenance, and enrichment of technology and equipment used in operations, focusing on optimizing reliability, sustainability, and performance to meet the evolving needs of our customers.

In 2023, we structured our efforts to industrialize at scale. The 5“R” framework serves as a starting point to monitor and track improvements in our collective efforts, making circularity not only paramount for sustainability but also for our business impact. Aligning sustainability gains with profitability provides a greater incentive for innovation and expansion. Additionally, we’ve pursued innovation in sustainability challenges by leveraging data insights, machine learning, and video analytics, enhancing efficiency by reducing waste and enabling data-driven decisions for a more significant impact.

SLB Operations and Product Sales

Users and clients play a fundamental role in enabling circularity as their behaviors, choices, and demands significantly influence the adoption of sustainable practices. By fostering awareness and promoting a circular mindset among users, we can encourage responsible consumption, product longevity, and end-of-life considerations.



SLB CIRCULARITY LOOP

In 2023, TLM teams defined their strategy towards circularity, with the 5“R” Framework.

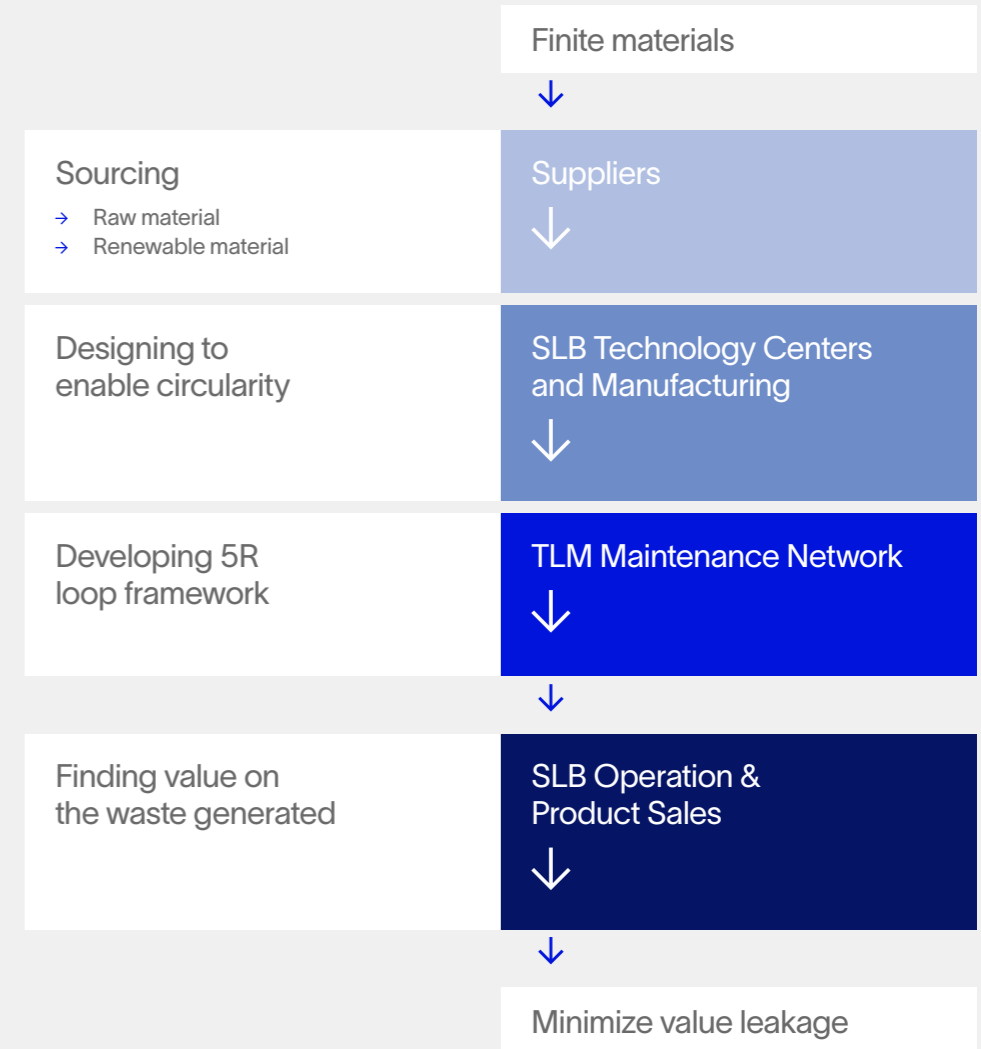

Enabling Circularity continued

Reduce

Innovations in sustainability-focused challenges have led to the development of the industry-first Prognostics and Health Management (PHM) solution to analyze and recommend an optimized condition-based maintenance plan by predicting the remaining useful life of the limiting components. Condition-based maintenance is the practice of performing maintenance activities based on the tool's current state considering previous operations rather than on a predetermined schedule leading to reduction of waste, materials and supplies spend, and logistics. In addition to the benefit of life extension of existing assets, these digital tools have reduced risk and increased the reliability of our technology, delivering greater performance for our clients.

In the Well Construction Division, condition-based maintenance using PHM has resulted in a 25% increase of useful life of the mud motor, a critical component used in well drilling, providing the opportunity to perform more drilling runs. In this application, the system not only assesses the health of the mud motor but also introduces a new service for our clients, offering a competitive advantage in the market.

Reuse

Reusing parts is a sustainable and cost-effective practice that significantly contributes to resource conservation. Historically, TLM depended on the knowledge of local experts to verify if a component is reusable. Introducing cutting-edge visual analytics in the inspection process has expanded the reach of this initiative, increased accuracy, volume, and reduced inspection time.

One example of this is the Digital Surface Inspector in the Production Systems Division. The Inspector applies machine learning algorithms to images of valve gate surfaces to detect defects. Since its inception, it has increased the volume of reused valve gates, curbing the need for manufacturing 4,100 new units, while also preventing the generation of over 122,000 kilograms of scrap waste.

>122,000 kg

of scrap waste prevented by the Digital Surface Inspector

Refurbish

In 2023, through the combined efforts of the Well Construction Division and the Reservoir Performance Division, over 2,800 drilling collars and other components were repaired, resulting in significant cost savings and a reduction of CO₂e emissions by 330,000 metric tons. In Reservoir Performance, the expanded capabilities of the network resulted in the refurbishment of over 1,400 printed circuit boards to like-new condition, contributing to an estimated 1,600 metric tons reduction of CO₂e emissions. This remarkable achievement not only paved the way for repairing and refurbishing other key technologies, but also reduced the turnaround time of this critical component to better serve our clients.

Remanufacture

In 2023, various innovative ideas took shape across different divisions. One notable initiative involved repurposing material from scrapped collars to locally remanufacture parts that will have a different functionality, thereby avoiding waste.

330,000 tCO₂e

emissions reduced by the TLM Circularity Network in 2023

>2,800

drilling collars and other components repaired or remanufactured for different uses

Recycle

The Rankin Bits Technology Center partners with tungsten carbide manufacturers to collect decommissioned matrix bits. The matrix (tungsten carbide) is separated from the steel pin connection, and it undergoes a grinding process for further refinement. This program on average yields a minimum of six kilograms of avoided CO₂e emissions per kilogram of material recycled. In the period spanning 2020 through 2023, this has totaled more than 3,000 avoided metric tons of CO₂e emissions.

EMPOWERING LOCAL TEAMS IN CIRCULARITY:

Azerbaijan Waste Reduction Program

All SLB facilities in Azerbaijan have successfully eliminated single-use items. This achievement, driven by collaboration and a shared vision for sustainability, reflects our commitment to the environment. Over 300,000 paper cups and 32,000 plastic bottles were replaced in Azerbaijan.

In 2023, TLM made significant progress in advancing circularity at scale and improving outcomes by leveraging digital intelligent solutions. These efforts have not only made a step change in circularity gains but have made a significant business impact.



Enabling Circularity continued

In 2023, we developed and rolled out a companywide eLearning course “Enabling Circularity at SLB.” This training explains the concept of circularity and how it relates to SLB and our sustainability approach, identifies factors that impact circularity, and provides circularity examples on extending lifetime of the product and reducing waste.

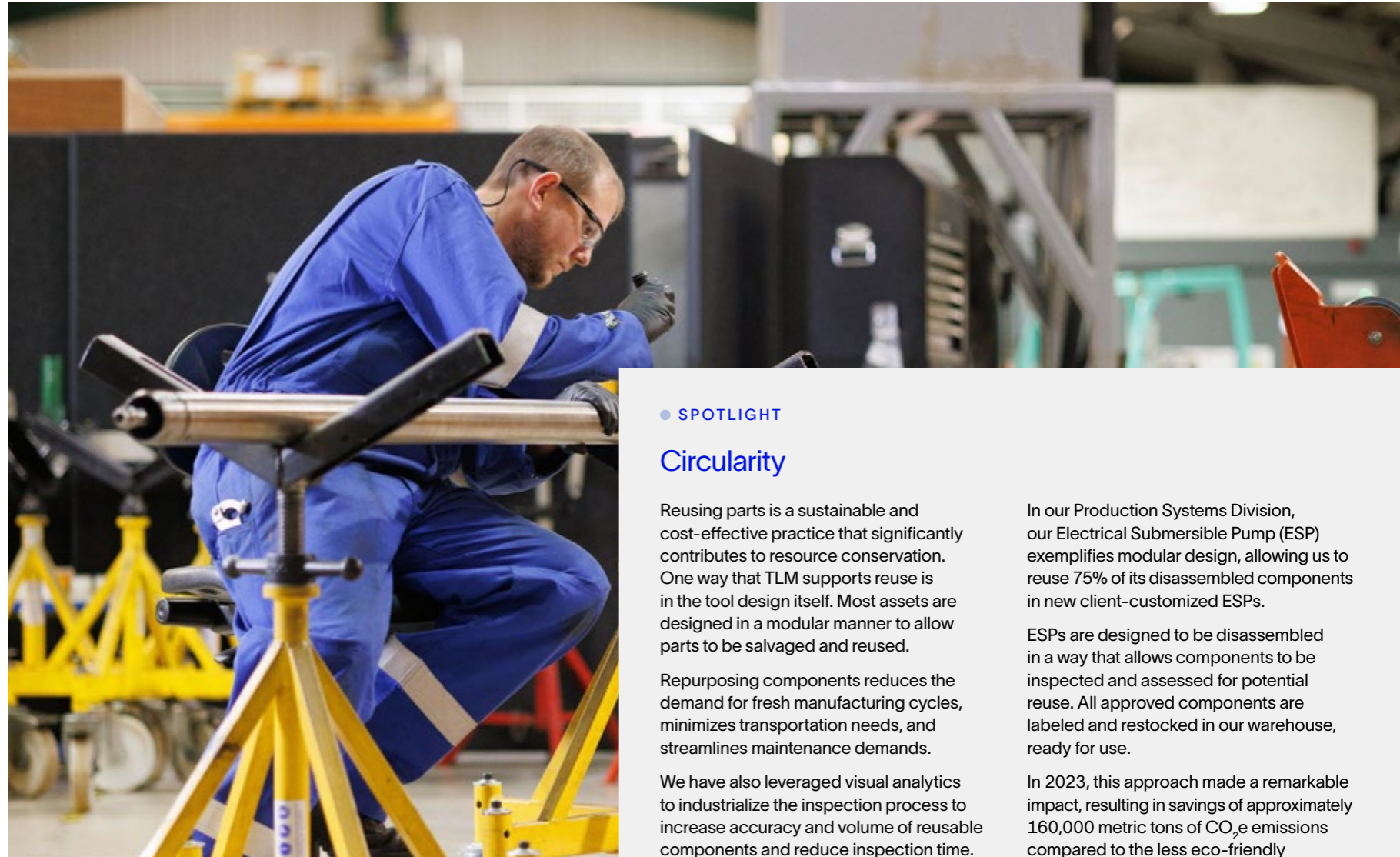

● SPOTLIGHT

Circularity

Reusing parts is a sustainable and cost-effective practice that significantly contributes to resource conservation. One way that TLM supports reuse is in the tool design itself. Most assets are designed in a modular manner to allow parts to be salvaged and reused.

Repurposing components reduces the demand for fresh manufacturing cycles, minimizes transportation needs, and streamlines maintenance demands.

We have also leveraged visual analytics to industrialize the inspection process to increase accuracy and volume of reusable components and reduce inspection time.

In our Production Systems Division, our Electrical Submersible Pump (ESP) exemplifies modular design, allowing us to reuse 75% of its disassembled components in new client-customized ESPs.

ESPs are designed to be disassembled in a way that allows components to be inspected and assessed for potential reuse. All approved components are labeled and restocked in our warehouse, ready for use.

In 2023, this approach made a remarkable impact, resulting in savings of approximately 160,000 metric tons of CO₂e emissions compared to the less eco-friendly alternative of manufacturing entirely new components.

Governance

We have embedded the management of sustainability risks and opportunities at all levels of our company, including robust and effective Board oversight.

SLB's sustainability programs and initiatives are driven by executive management and overseen by the Board. Led by the Chief Strategy and Sustainability Officer (CSSO), sustainability is integral to our corporate strategy. The Vice President of Sustainability, reporting to the CSSO, focuses on social and environmental aspects, including engaging stakeholders. Our line management is directly responsible for the management and mitigation of the environmental impact of our operations. Our Vice President of Health, Safety, and Environment (HSE) is responsible for our environmental management systems, and our Vice President of Sustainability is responsible for our global sustainability strategy and programs. For details about our environmental management standard and how we manage environmental risk see [here](#).

Board Oversight of Sustainability

The Board and its committees oversee the performance and management of various environmental, social, nature, and other sustainability issues, including our energy transition strategy, emissions reduction targets, climate change, sustainability reporting, workforce health and safety, human rights, workforce diversity, biodiversity, water resources, and ethics and compliance.

The Board oversees SLB's long- and short-term strategy, including our roadmap to achieve our 2050 net-zero commitment, and the Board delegates to the Nominating and Governance

Committee oversight of our sustainability programs, initiatives, and activities. The Board's other committees oversee sustainability-related topics within their respective areas of responsibility, such as the incorporation of sustainability and diversity metrics into our compensation incentive programs (Compensation); the growth potential, maturity, and viability of our targeted New Energy business sectors (New Energy and Innovation); the conduct of sustainability-related reviews by our internal audit team (Audit); operational risks such as cybersecurity (Audit); the disclosure of ESG risks (Audit and Nominating and Governance, jointly); and the development of our sustainable finance strategy, including financial instruments with rates linked to climate commitments (Finance).



[Learn more here](#)



To enhance our governance framework, a mapping of our operational risks was completed by 100% of our regions and divisions. The 2023 mapping considered emerging and new risks to align with our sustainability priorities.

SPOTLIGHT

Integrating Sustainability in Management Compensation

Ten percent of our executive officers' short-term incentive pay was based on quantitative non-financial goals focused on reducing our Scope 3 emissions intensity and improving gender balance in our workforce. Additionally, all our named executive officers had strategic personal objectives related to New Energy and/or HSE performance goals. For details about these objectives and a description of our executive compensation program see 2024 Proxy statement [here](#).

In addition, in 2023, key populations across SLB management were assigned sustainability personal objectives focused on reducing Scope 1, 2, and 3 GHG emissions in our field operations and facilities, customer avoided emissions, sustainability planning, and supplier disclosures.

Ethics & Compliance

Our sustainability program is rooted in our long-standing commitment to effective corporate governance and business integrity.

Launching A New Code of Conduct – Together with Integrity

In April 2023, the SLB Board of Directors approved and adopted a revised code of conduct entitled “Together with Integrity – Our Code of Conduct” reflecting and reinforcing the company’s newly implemented cultural framework, values, and behaviors. The revised “Together with Integrity” expands and re-emphasizes SLB’s core expectation for its officers, directors, employees, and suppliers to act with integrity in an evolving world. The revisions were designed to enhance the impact and relatability of the Code, providing clarity in an easily digestible style, including the addition of Integrity in Action guidance for practical application. In addition, the revised Code of Conduct emphasizes and reiterates reporting channels to help everyone feel empowered to speak up.

The roll-out of the Code of Conduct was a global campaign of engagement across the whole SLB organization. The CEO and Chief Legal Officer led the management team in launching the Code of Conduct through both interactive virtual and live events, including localized events around the globe, designed to engage and spread awareness and training on the values and expectations of the new Code of Conduct.



You can learn more about SLB Code of Conduct by clicking [here](#)

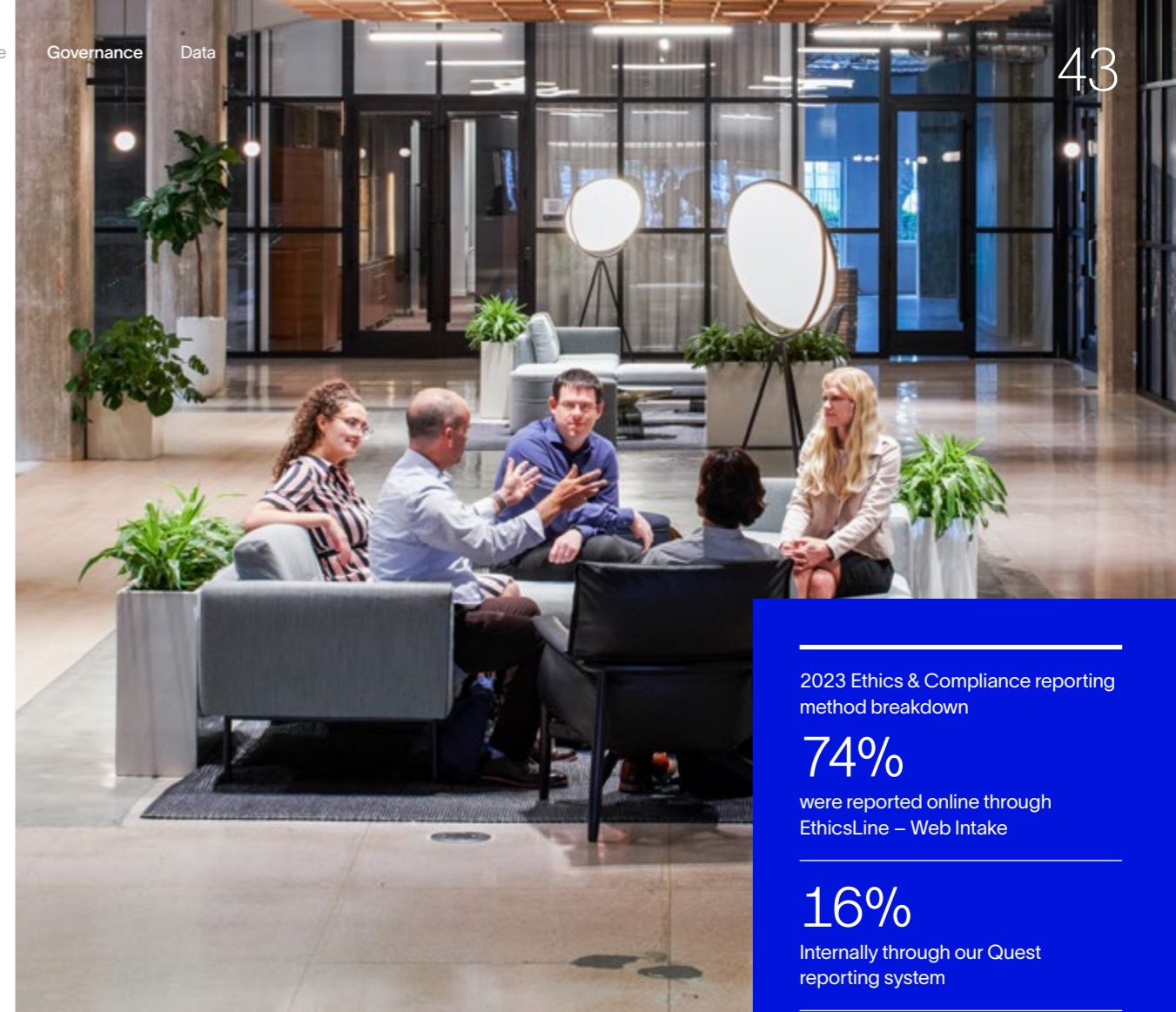

2023 Ethics & Compliance reporting method breakdown

74%

were reported online through EthicsLine – Web Intake

16%

Internally through our Quest reporting system

8%

Through the externally hosted EthicsLine telephone line

2%

Via other reporting methods

Ethics & Compliance continued

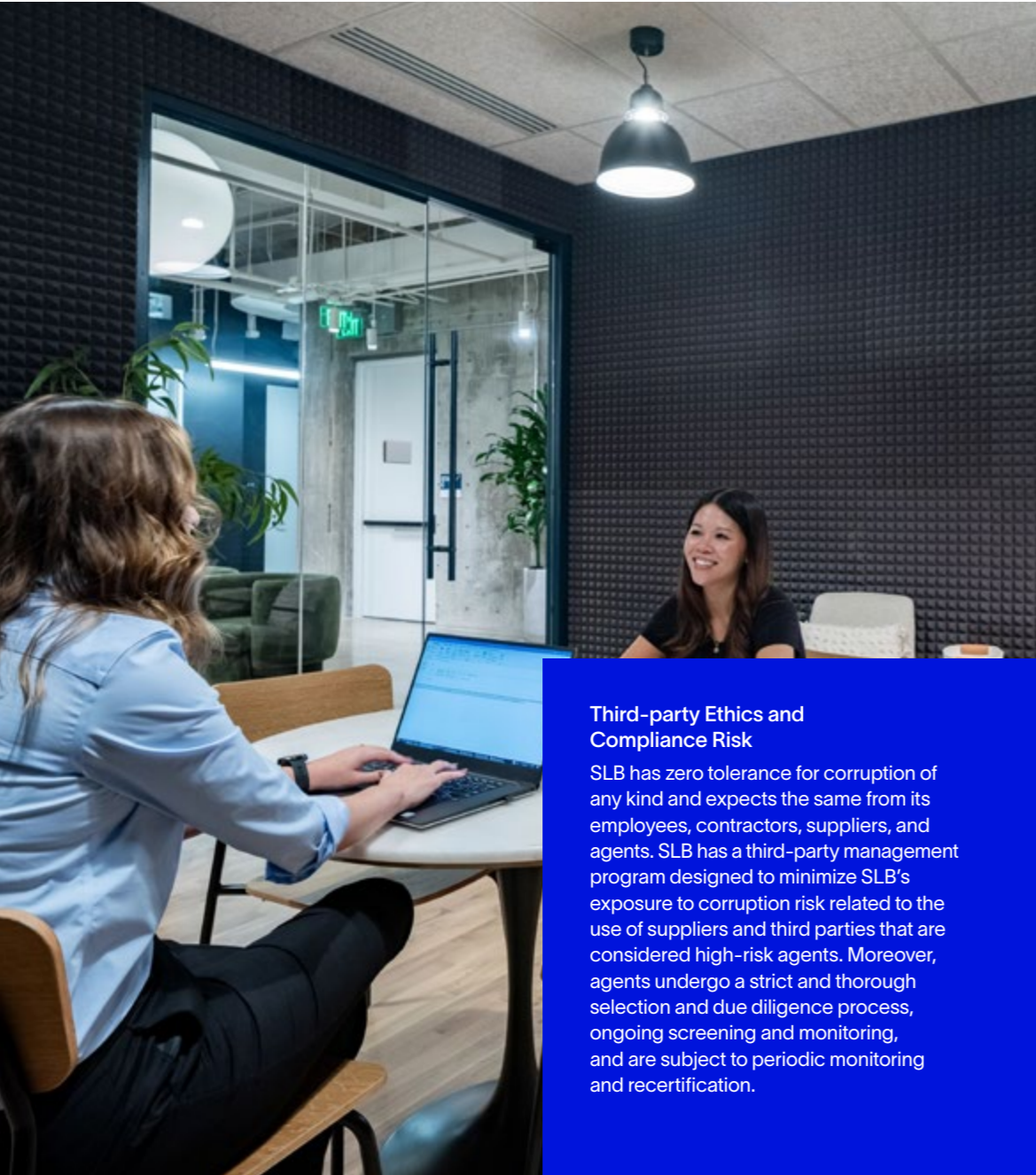

Third-party Ethics and Compliance Risk

SLB has zero tolerance for corruption of any kind and expects the same from its employees, contractors, suppliers, and agents. SLB has a third-party management program designed to minimize SLB's exposure to corruption risk related to the use of suppliers and third parties that are considered high-risk agents. Moreover, agents undergo a strict and thorough selection and due diligence process, ongoing screening and monitoring, and are subject to periodic monitoring and recertification.

Operation Assurance Reviews – Integrity Walk-arounds

Every year, SLB's legal department conducts Operations Assurance Reviews (OARs) of locations around the world to assess compliance with the company's Code of Conduct, policies and other corporate standards. These reviews are tailored to the locations. OARs are an important assessment tool of our operations for compliance with SLB policies, standards, and procedures, and will inform, together with other risk management initiatives, the unique risk profile for the particular locations.



In 2023, SLB implemented an "Integrity Walk-around" component to the OAR, focusing on unfiltered conversations with local employees, contractors, and other third parties to raise awareness around human rights and forced labor issues. This new process facilitates honest discourse in an unscripted and informal manner, allowing for candid discussions on human rights matters, such as local awareness of grievance reporting mechanisms (whistleblower process), disparity in pay processes, and others. This new Integrity Walk-around is providing a unique insight into how human rights issues may impact populations across SLB locations.

2023 TRAINING COMPLETION RATE

86%

Professionalism and Respect in the Workplace

93%

Manager Compliance Training

93%

Non-Manager Compliance Training

Stakeholder Engagement

Stakeholder engagement is critical to supporting our governance and sustainability efforts.

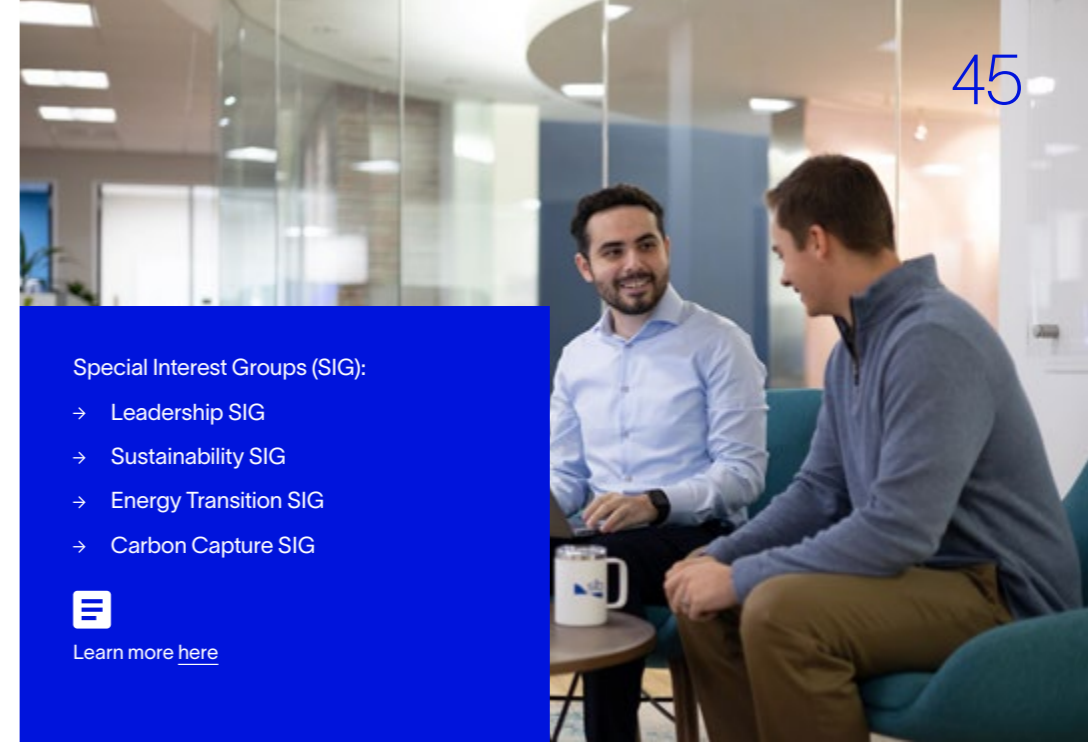

Special Interest Groups (SIG):

- Leadership SIG
- Sustainability SIG
- Energy Transition SIG
- Carbon Capture SIG



[Learn more here](#)

By actively listening to stakeholder feedback, we gain valuable insight that helps us manage sustainability risks, align our business processes with local and national priorities, needs, and expectations, identify new business opportunities, maintain our social license to operate, and increase the productivity of our workforce.

Engage to Excel

Each year, SLB conducts an annual engagement survey worldwide to measure workforce engagement and employee perception. The E2E survey continues to serve as the cornerstone element of SLB's commitment to listening to the "voice of the employee" and ensuring we take relevant action to address employee engagement. In 2023, the participation rate hit 92%, placing us in the top 1% of external benchmark for companies of similar size. Overall, our engagement index increased 400 basis points compared to 2022. This brings us closer to our goal of reaching the top quartile by continually taking action to impact the overall employee experience at SLB.

We also observed a significant improvement in the response for if employees feel SLB is committed to sustainability, reflecting the company's strong commitment to being at the heart of the sustainable energy transition.

Our Commitment to Stakeholders

SLB strives to maintain and grow the trust and confidence of our customers and shareholders as well as all other stakeholders affected by our operations. When we clearly behave in an ethical manner, we enhance our reputation as a partner, employer, and community member.

Celebrate the Leader in You: The Role of Leadership in Evolving Our Culture

The SLB Leadership Special Interest Group (SIG) recently hosted its annual Engage in Leadership Symposium at the United Way of Greater Houston. In honor of the SIG's 10th anniversary, this year's theme was "Celebrate the Leader in You." A variety of key topics from our cultural framework were covered, including leading with respect, focusing on what matters most and championing experimentation, learning, and growth. As we continue to evolve our culture around our three core values of people, technology, and performance, including the nine behaviors associated with them, leadership is an important part of making this evolution a success.

Employee Volunteering

The focus of our community volunteering program is to:

- build engagement within our teams by hosting events that invite them to share their skills and expertise with their communities
- foster strong relationships within our communities by structuring our volunteering around the SDGs
- provide support for communities that have been affected by a natural disaster.

In 2023, our employees logged over 1,700 days of total volunteering time, captured in our global time tracking tool.

Stakeholder Engagement continued

Sustainability Outreach Initiatives

Sustainability Roadshow

Launched in Europe, the Sustainability Roadshow program aims to raise awareness about SLB’s commitment to sustainability aligned with its climate action, people, and nature priorities. Over 35 roadshows engaging more than 2,000 employees improved employee engagement and understanding of the organizational priorities.

● SPOTLIGHT

Strategic Partnerships

In 2023, SLB joined more than 200 forward-thinking companies as a member of the World Business Council for Sustainable Development (WBCSD).

“SLB’s unwavering commitment to sustainability and its global footprint make it a valuable addition to our community. Technology and innovation are key enablers of sustainability frameworks today.

Their global reach and vision of sustainability as a key performance benchmark will empower them as a crucial player to help create the building blocks of transformation as envisioned by the Council. Together with WBCSD, SLB will aim to catalyze transformative action to achieve a better world where 9+ billion people live well within planetary boundaries by mid-century.”

Peter Bakker
CEO and President of WBCSD

UN SDG Innovation Accelerator

In 2023, SLB actively engaged in the UN SDG Innovation Accelerator for Young Professionals program, a nine-month initiative by the UN Global Compact. This program emphasizes a design thinking approach to drive solutions aligned with the UN SDGs. SLB teams, as part of this program, focused on developing a sustainable impact project, choosing to explore opportunities for creating technology aimed at producing synthetic aviation fuel.

Customers

Enhancing Customer Experience

In 2023, we focused on engaging major customers, reducing and avoiding customer emissions, collaborating on sustainability initiatives, and responding to carbon footprint reduction partnerships. Our dedication extends beyond operational decarbonization and digital for our customers; it involves developing cutting-edge Transition Technologies to minimize environmental impact throughout the exploration and production life cycle.

Investor Relations and Market Outreach

At investor-focused events like the Bernstein Annual Strategic Decisions Conference and JPMorgan Energy, Power, and Renewables Conference, SLB executives emphasized the durability of the oil and gas cycle and the resilience of the offshore market. At the Barclays CEO Energy-Power Conference, focus shifted to showcasing the transformative power of core operations and digital technologies for sustained growth.

Governments and Policymakers

Governments and policymakers actively seek SLB experts for their knowledge and experience in various aspects of the oil and gas industry. SLB is politically neutral, but offers technical support to regulatory officials interested in gaining practical insights into technologies and processes that mitigate emissions and reduce our industry’s carbon footprint.

SLB does not use corporate funds or resources for political campaign contributions or advocacy, but we do pay regular dues to industry groups where necessary for membership. We work with various think tanks and non-governmental organizations, some of which wield policy influence, to collectively support industry initiatives, including those focused on sustainability and decarbonization efforts.

University Collaborations

Our university engagements are key for our recruiting and sustainability programs. We support STEM education and research, and attract diverse, talented graduates from local universities in our operating countries.



[Learn more here](#)

UNIVERSITY NUMBERS

Recruiting Job Applications (approximate)	~ 207,000
Countries	95
Universities recruited at	803

Global Impact Events:

- **COP 28:** We firmly believe the oil and gas industry must have a seat at the table in climate change negotiations and in 2023, we were proud to have participated in COP28. As a leading technology provider with tangible solutions, we demonstrated our role as a change agent for decarbonization and new energy innovation with industry leaders, governments, investors, customers, climate advisors, non-government organizations, youth groups, and the general public.
- **NY Green Forum:** In September, SLB actively participated in New York Climate Week, fostering collaboration and knowledge exchange with diverse industry partners and visionary thought leaders. Chief Strategy and Sustainability Officer Katharina Beumelburg and VP, Sustainability Mikki Corcoran played integral roles in a series of activities, including dynamic roundtable discussions, impactful one-on-one meetings, and top-tier media interviews. This successful effort garnered prominent news coverage and facilitated insightful dialogues with other sustainability leaders.
- **Reuters Events: Global Energy Transition 2023 and Responsible Business Awards:** Alongside our industry-leading peers at the Reuters Events: Global Energy Transition 2023, we committed to a collective vision of the global energy transition. Through collaboration, we will accelerate the speed of innovation for a decarbonized, diversified, and digitalized energy system.
- **As a Finalist at the Reuter’s Events: Responsible Business Awards 2023,** SLB also attended the Responsible Business Leaders Forum and the Gala Dinner in London.

Responsible Supply Chain

Our Planning and Supply Chain organization is dedicated to creating value and driving resource consciousness for a balanced planet. We aim to foster cooperation among all stakeholders within and beyond our value chain.

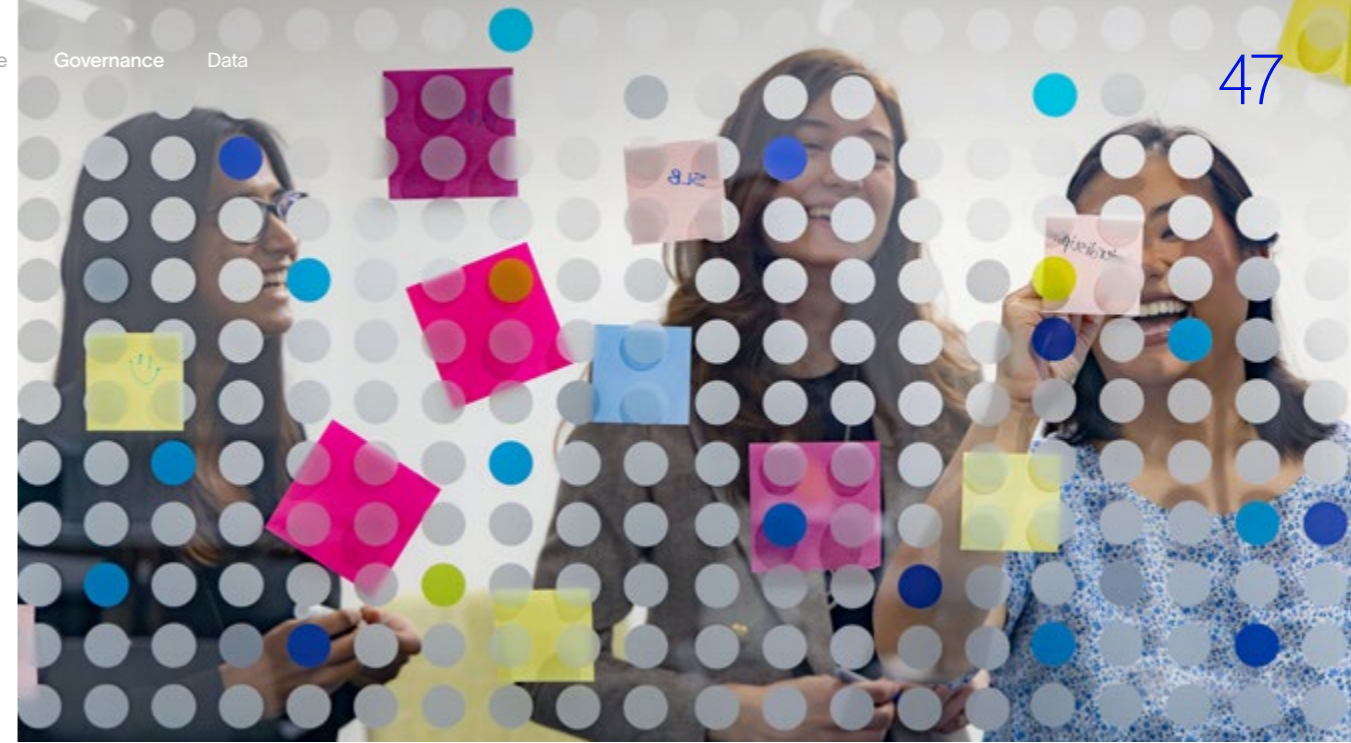

CDP Supply Chain Program

In our third year as a CDP Supply Chain member, we benchmarked supplier sustainability maturity globally, gaining insight into how we can leverage our supply chain to achieve our Scope 3 targets. SLB's program, the second largest in supplier requests, achieved an 83% response rate, with a 19% improvement from 2022. We actively support our suppliers through training, webinars, and periodic reviews, emphasizing climate action. Explore details in the [CDP Supply Chain Report 2022, page 44](#).



[Learn more here](#)

CDP SUPPLY CHAIN

	2023
Number of suppliers engaged	1,354
Percentage of total Scope 3 upstream emissions covered by engaged suppliers	61%
Percentage of prior year's spend represented by suppliers engaged	54%
Total number of responding suppliers	1,124
SLB supplier response rate	83%
Average CDP Supply Chain member response rate (as reported by CDP)	59%

Responsible Supply Chain continued

Elevating Climate Action in Sourcing

In 2023, we integrated climate action into our sourcing strategy for high-emission product categories. Using our suppliers' CDP scores, or our SLB Climate Action Request questionnaire, we assign a climate score to each supplier invited to tender, accounting for a portion of the overall supplier evaluation, influencing RFP award recommendations. This initiative incentivizes the most mature suppliers and those showing year-on-year progress.

Our next objective is to refine our climate assessment factor to the actual carbon footprint of purchased products. This evolution demands suppliers enhance their capability in calculating and sharing PCFs for standardized comparisons.

Integrating Climate Action in Contracts

An Environmental Sustainability Exhibit has been introduced into our suppliers' contracts. This formalizes the minimum climate action expectations for our critical suppliers. We ask for public disclosure of suppliers' environmental performance, mandatory reporting of Scope 1 and 2 emissions, structured emissions reduction targets, and PCF data.

Supplier Innovation Program

In 2023, our Supplier Innovation Program expanded to address challenges across different geographies, including challenges on exploring low carbon alternatives, green logistics, and circularity. Out of 156 proposals received in the sustainability challenges, 36 were selected for implementation.

Decarbonizing Distribution

Introduced the Distribution Value Plan (DVP), strategically identifying opportunities for cost optimization, efficiency enhancement, lead time reduction, GHG emission minimization, and overall value maximization. This initiative creates a culture of continuous improvement, innovation, and collaboration within our supply chain teams.

Logistics Sourcing Best Practices

In 2023, we implemented logistics sourcing best practices that give preference to suppliers with fewer emissions.

EPA SmartWay Program

A successful project involved managing United States transportation through the United States Environmental Protection Agency (EPA) SmartWay Program, focusing on clean, energy-efficient freight movement. Outsourcing trucking services for over 150 vendors to a central point has ensured continuous improvement in all SLB trucking vendors participating in the SmartWay Program, covering 100% of United States railroad transportation suppliers.

● SPOTLIGHT

DVP Impact in 2023

The Distribution Value Plan in 2023, comprised a pipeline of almost 70 projects, contributing to a reduction of over 22,000 metric tons of GHG emissions. Our supply chain network optimization models now include emissions reductions, allowing decision-makers to balance economic and delivery efficiency with sustainability.

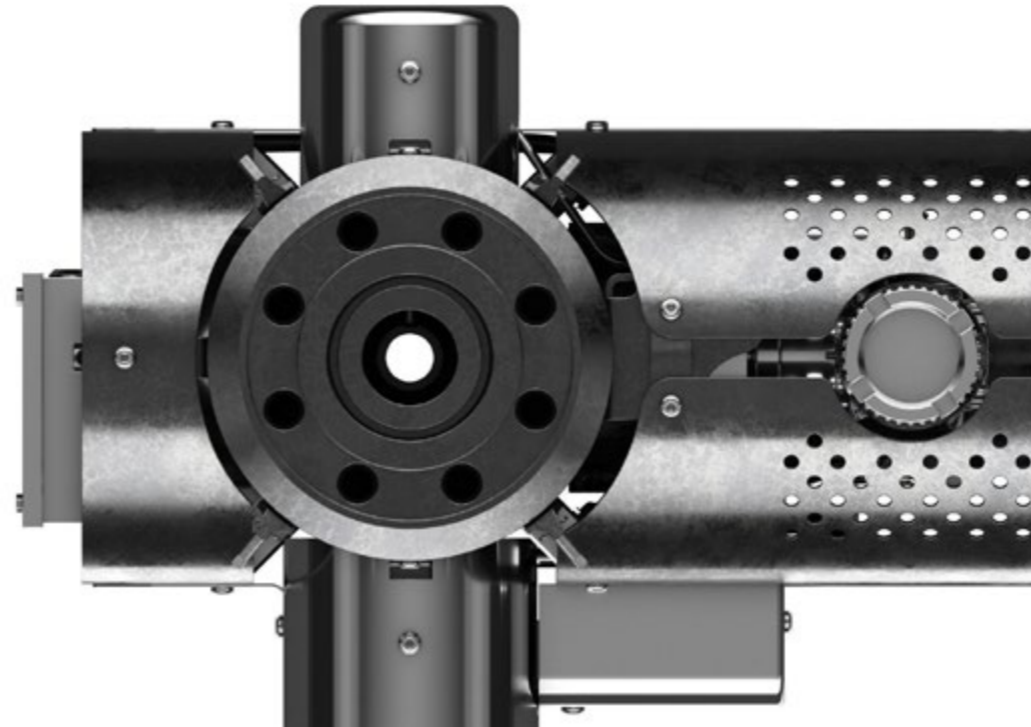
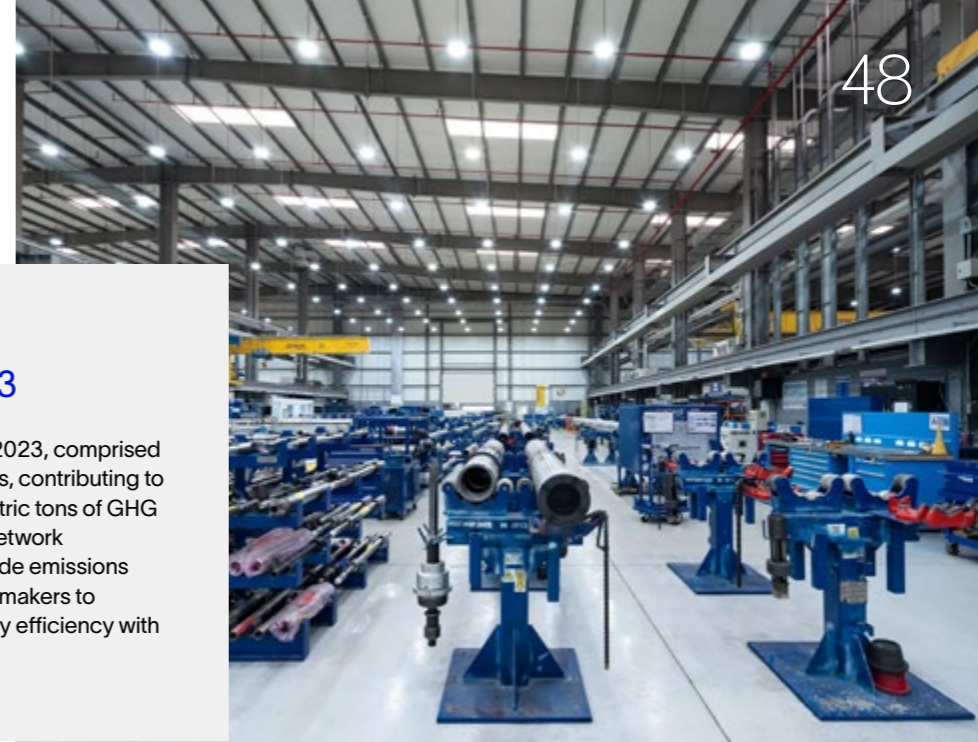

Advancing Toward Product Carbon Footprint (PCF)

In 2023, we focused on improving our corporate level baseline emissions data for Scope 3 Category 1, identifying that chemicals and manufacturing purchased goods and services make up 70% of emissions. The pilot of the PCF data calculation is aligned with GHG protocol and industry specific guidelines. We focused on defining calculation boundaries for products and services with the most significant emissions, shifting to an activity based calculation. In parallel, we are continuously engaging our critical suppliers to obtain product level primary data to identify opportunities for emissions reduction. Pilot outcomes will shape reduction strategies going forward.

Responsible Supply Chain continued

Supplier Diversity and Inclusion

As a globally recognized company, we value inclusion as a key driver of our business success.

We received the 'Innovate' award in Australia, acknowledging strides in reconciliation initiatives. The SLB Australia Indigenous Procurement Policy recognizes Indigenous businesses as vital partners, reflected in a remarkable three-fold increase in expenditures with First Nation businesses and a concurrent 167% rise in Indigenous suppliers.

A third-party study was completed in 2023 to understand the supply chain diversity and inclusion gaps in the countries where we operate and develop a social impact roadmap, learning from external best practices and benchmarks. Following this, we enhanced our diversity and inclusions programs in United States, Canada, and Australia, and selected additional geographies for inclusion pilots.



UAE

In United Arab Emirates, our localized sourcing initiatives led to:

- Increase in-country spend of \$1.2 million
- Achieved a reduction in CO₂ emissions of approximately 1,500 metric tons CO₂e

Regionalization and Localization Impact

Our supply chain is focused on meeting region-specific needs, enhancing resilience and efficiency. We successfully completed over 600 local sourcing projects in 2023. Our commitment is underscored by winning the 7th edition of the In-Kingdom Total Value Add (iktva) awards in Saudi Arabia, with over 85% of third-party spending sourced locally in Saudi Arabia.

Minerals Commitment

SLB is committed to purchase only those parts and products containing minerals that have been procured through a validated conflict-free supply chain to avoid the use of minerals that have financed conflict in the covered countries, and we expect our suppliers to abide by the same standard. More information can be found at our Conflict Minerals Position Statement and in the Modern Slavery Statement.



[Learn more here](#)

Capacity Building for Sustainability

In line with SLB's prioritization of learning and development, over 75% of key supply chain leaders have completed sustainability training. In 2023, we integrated sustainability training into all levels of our Supply Chain training programs, reaching over 30% of the total supply chain population. We partnered with the University of Exeter to tailor the Circularity Masterclass to our organization, training almost 200 people in 2023. Collaborating with Climate Fresk, we aim to deliver baseline training to over 80% of the supply chain organization by the end of 2024, emphasizing our dedication to a knowledgeable and sustainable workforce.

Quality, Health, Safety, and Environment

During 2023, we achieved a workforce fatality-free operation and lowest workforce total recordable injury rate, making 2023 a record year for SLB's HSE performance.



Our strong SLB safety culture has been evolving with the incorporation of impactful programs, technology, and training and competence development. We have integrated the SLB safe culture not only within our employees and families but also with our contractors and customers and other third parties. We collaborate proactively to share best practices and initiatives, which focus on what matters most, keeping people safe, preventing life-changing injuries, and operating in a fatality-free environment.



[Learn more here](#)

SLB aligns with industry best practices and is committed to implementation. Specifically, we follow IOGP's Life Saving Rules and Process Safety Fundamentals, and they are integrated into our day-to-day activities and culture to keep people safe.

SAFETY

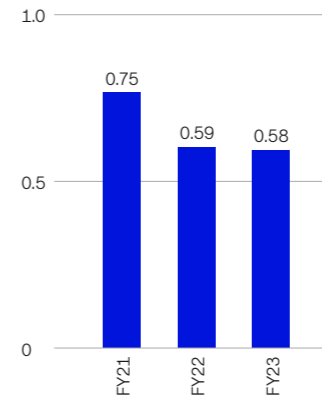

TRIR (Total Recordable Injury Rate frequency) per 1 million work-hours, as per International Association of Oil & Gas Producers (IOGP)

In 2023, we recorded more than 4.5 million HSE training hours, averaging over 33 HSE training hours per person.

Quality, Health, Safety, and Environment continued

HSE INDICATOR	OBJECTIVE ¹
Total Recordable Incident Frequency (TRIF), with fatality free qualifier, per million work hours ^{2,3}	Reduce the Global TRIF by 10% from 2022 Achieved
Automotive Accident Rate per million miles (AARm) (internal) ^{2,3}	Maintain AARm at 2022 level Achieved and improved
High Potential incidents time-bound reviews and closures	Complete 100% within allotted timeframe

1. Reflects only company-wide objectives and achievement levels. Geographic- and business line-specific objectives and achievement levels are not reflected.
2. Internal TRIF and AARm metrics reflect all SLB-involved incidents or accidents, as applicable, including incidents that are not required to be recorded by IOGP or OSHA (such as incidents occurring during off-duty hours). As a result, these internal performance metrics do not match our industry-recognized TRIF and AARm figures in the performance data table.
3. This includes employees and applicable contractors. "Applicable contractors", refers to the contractors whose performance was included in our global QHSE business system as of December 31, 2023. These contractors are to some degree under SLB operational control, and so are included in our safety metrics following IOGP best practices relating to contractor management (Mode 1 and Mode 2 contractors, as defined in IOGP Report 423).

PRODUCT AND SERVICE SAFETY 2023 PERFORMANCE OBJECTIVES

Product Safety & Services Indicator	2023 Objective	Achievement
Zero tolerance events (ZTEs) – Covers hazards associated with well integrity, process safety, pressure, and management practices used in our services or sold as products.	Target of Zero ZTEs	✓ ACHIEVED

Product and Services Safety

Our operations integrity team leads our commitment to providing safe, reliable, and efficient operations to our customers. We ensure operational integrity and drive performance so we can consistently deliver superior services and products. Product safety and services are key to our success and support SLB’s sustainability commitment to protect people, our communities, and the environment, and to deliver high-quality technology, performance, and services to our customers.

Safe

Our operations integrity teams proactively manage hazards related to product and service safety. We are focused on end-to-end management of the lifecycle of all product and service safety including a network of product and service safety experts at all levels of SLB’s organization from the global governance and lifecycle management level to operations.

Reliable

We continue to focus on service and product quality and reliability of our services. In 2023, we achieved our best reliability performance on record.

Efficient

SLB is using its technology and advanced IT capabilities to further reduce its operational footprint through the expansion of remote operations. A key impact of this expansion is the reduction of travel to and from the well site, reducing the CO₂ emissions associated with such services.

Quality, Health, Safety, and Environment continued

Behavioral Science applied to HSE

Our processes, tools, communications, and other initiatives are designed with end-users in mind.

Health & Wellbeing

The Live Well vision is for SLB to have the healthiest and happiest employees in our industry.

Product and Services Safety

We focus on end-to-end lifecycle management of product safety in our services and sold products.

Design for HSE

The HSE aspect of the technology Concurrent Lifecycle Management System (CLMS) was updated in 2023 to better reflect our evolving technology development process that works safely with our local contractors.

Transportation Safety and Technology

During 2023, our performance was recognized by the Network of Employers for Traffic Safety (NETS) as the second highest-ranking company in their benchmark annual scoring for company traffic safety.

Training and Communication

By delivering learner-centered training programs, we facilitate the information and HSE tools for our employees and contractors to manage risks, implement prevention measures, and assess controls in their work environments.

Safe Transportation of Hazardous Materials

SLB has a robust program to manage the safe transportation of hazardous materials.

SLB has product- and service-specific safety standards to manage risks for hazardous materials in addition to local and international regulatory requirements. If transported, all movements of hazardous materials must be in accordance with regulatory requirements and our internal standards for driving and product and service safety specific standards.

Chemicals Management

Continuing our efforts toward next-level product and environmental stewardship, SLB undertook to automate its process for addressing new chemical suppliers in 2023. This includes the management of products in our supply chain that could have health or environmental impacts.

SLB actively manages and mitigates the risk these products may pose through:

- transparency in its supply chain
- exploring substitution for safer alternatives (when possible)
- monitoring changes in regulations
- collaboration with suppliers to find safer alternatives and improve supply chain sustainability.

SLB QHSE Awards

- Society of Petroleum Engineers, Health, Safety and Environment Award in 2023
- USL Industry award – President’s Certificate of Recognition Energy Workforce & Technology Council
- 2023 Canada’s Safest Employers Award
- 2023 Occupational Health and Safety Honors Canada – SLB Best use of safety technology
- Shell – Safety Award Upstream category- SLB Malaysia.

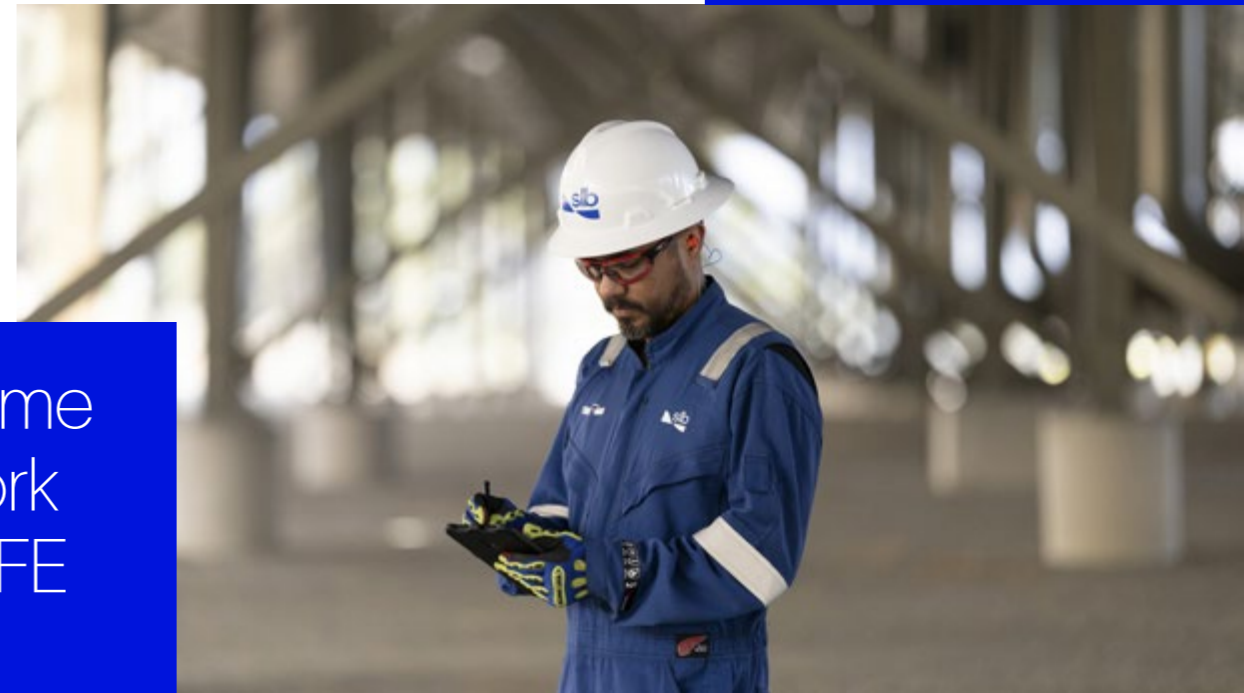

Safe at home
Safe at work
Safe for LIFE

Data Privacy and Cybersecurity

Our success as a global technology company depends on our ability to provide effective data security protection in connection with our digital technologies and services.



We rely on information technology networks and systems for internal purposes, including secure data storage, processing, and transmission, as well as in our interactions with our business associates, such as customers and suppliers. We also develop software and other digital products and services that store, retrieve, manipulate, and manage our customers' information and data, external data, personal data, and our own data. For additional information, view our [Privacy Statement](#) and [Data Privacy and Cybersecurity](#).

Cyber partners are key to our cyber strategy. We partner with leading cybersecurity companies and organizations, leveraging third-party technology and expertise. We engage with these partners to monitor and maintain the performance and effectiveness of products and services that are deployed in our environment.

We have a Cyber Security Operations Center operating in three locations to provide 24/7 monitoring of our global cybersecurity environment and to coordinate the investigation and remediation of alerts. A program for staging incident response drills is in place to prepare support teams in the event of a significant incident.

The cybersecurity team is responsible for assessing and managing our cyber risk management program, informs senior management regarding the prevention, detection, mitigation, and remediation of cybersecurity incidents and supervises such efforts. The cybersecurity team has decades of experience selecting, deploying, and operating cybersecurity technologies, initiatives, and processes around the world, and relies on threat intelligence as well as other information obtained from governmental, public, or private sources, including external consultants engaged by SLB.

The Audit Committee of the Board of Directors oversees our cybersecurity risk exposures and the steps taken by management to monitor and mitigate cybersecurity risks. The cybersecurity team briefs the Audit Committee on the effectiveness of our cyber risk management program, typically on a quarterly basis. In addition, cybersecurity risks are reviewed by our Board of Directors, at least annually, as part of our corporate risk mapping exercise.

The underlying controls of the cyber risk management program are based on recognized best practices and standards for cybersecurity and information technology, including the National Institute of Standards and Technology Cybersecurity Framework (NIST CSF) and the ISO 27001 Information Security Management System Requirements. SLB has an annual assessment, performed by a third party, of the Company's cyber risk management program against the NIST CSF.

Data Privacy and Cybersecurity continued

Training

All employees receive cybersecurity training based on their exposure and function. This starts with all employees and applicable contractors (who have a corporate IT identity) receiving annual general cyber awareness training and certification. All employees also participate in a global phishing awareness program with quarterly exercises, as well as frequent ad hoc exercises for the lowest performing phishing awareness populations. In addition, we are focused on keeping our cyber team well trained so they can respond to the latest cyber threats and attack techniques. We regularly conduct both internal and external cyber training, including certifications from external industry-recognized organizations such as SANS Global Information Assurance Certification (GIAC), Information Systems Audit and Control Association (ISACA), Information System Security Certification Consortium (ISC)2, and International Council of E-Commerce Consultants (EC-Council). These are further supplemented by vendor-specific training and certifications, as well as attendance and presentations at technical and vendor conferences.

KEY TRAINING METRICS

	Target	2023 Actual
Training – Annual Cybersecurity Certification	>95%	95%
Training – Data Privacy & Protection	>90%	91%
Training – Privileged User Account	>90%	95%
Drill-IT – Cybersecurity Incident Response Drills	>150	>360



Integrated, enterprise-aligned and consistent with standard frameworks

INTEGRATED RISK MANAGEMENT



SLB Cybersecurity Integrated Risk Management Platform

SLB CYBER PERFORMANCE

Peer Group Distribution over Rating Ranges

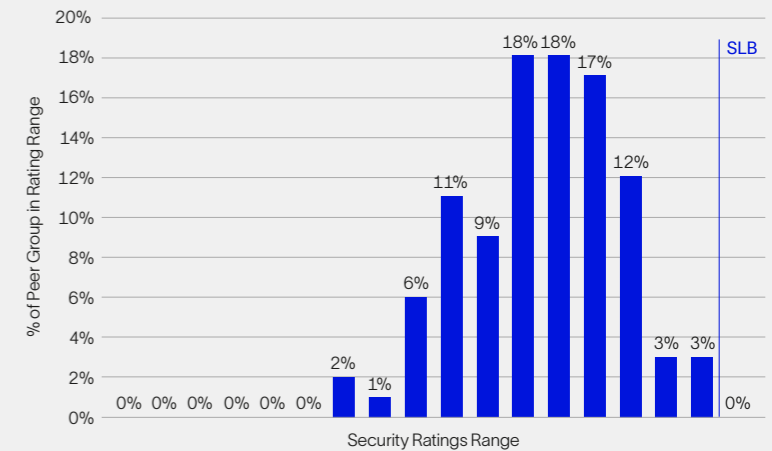

Sustainability Accounting Standards Board (SASB) Index

This report reference SLB's 2023 Form 10-K and 2024 Proxy Statement. These can both be found [here](#).

CORPORATE GOVERNANCE

Topic	Accounting Metric	Code	Information Location
Business Ethics & Payments Transparency	Amount of net revenue in countries that have the 20 lowest rankings in Transparency International's Corruption Perception Index	EM-SV-510a.1	<5% of our consolidated 2023 revenue
	Description of the management system for prevention of corruption and bribery throughout the value chain	EM-SV-510a.2	2023 Sustainability Report, Pages 43 - 44 Ethics & Compliance
Management of the Legal & Regulatory Environment	Discussion of corporate positions related to government regulations and/or policy proposals that address environmental and social factors affecting the industry	EM-SV-530a.1	2023 Sustainability Report, Pages 42 - 44, 46 Ethics & Compliance CDP C12.3
Critical Incident Risk Management	Description of management systems used to identify and mitigate catastrophic and tail-end risks	EM-SV-540a.1	2023 Sustainability Report, Pages 43, and 50 - 52 TCFD 2024 Proxy, Pages 20 - 21, 2023 Form 10-K , Pages 10 - 15 HSE

ENVIRONMENTAL

Topic	Accounting Metric	Code	Information Location	Topic	Accounting Metric	Code	Information Location
Emissions Reduction Services & Fuels Management	Total fuel consumed, percentage renewable, percentage used in: (1) on-road equipment and vehicles and (2) off-road equipment	EM-SV-110.a.1	2023 Sustainability Report, Pages 8, 11, and 68	Chemicals Management	Volume of hydraulic fracturing fluid used, percentage hazardous	EM-SV-150a.1	2023 Sustainability Report, Page 69
	Discussion of strategy or plans to address air emissions-related risks, opportunities, and impacts	EM-SV-110.a.2	2023 Sustainability Report, Pages 8 - 20 TCFD CDP C2		Discussion of strategy or plans to address chemical-related risks, opportunities, and impacts	EM-SV-150a.2	2023 Sustainability Report, Pages 51 - 52 Chemicals Management
	Percentage of engines in service that meet Tier 4 compliance for non-road diesel engine emissions	EM-SV-110.a.3	Not Reported	Ecological Impact Management	Average disturbed acreage per (1) oil and (2) gas well site	EM-SV-160a.1	Not Reported
Water Management Services	(1) Total volume of fresh water handled in operations, (2) percentage recycled	EM-SV-140a.1	2023 Sustainability Report, Page 69		Discussion of strategy or plan to address risks and opportunities related to ecological impacts from core activities	EM-SV-160a.2	2023 Sustainability Report, Pages 31 - 33
	Discussion of strategy or plans to address water consumption and disposal-related risks, opportunities, and impacts	EM-SV-140a.2	2023 Sustainability Report, Pages 34 - 37				

Sustainability Accounting Standards Board (SASB) Index continued

SOCIAL

Topic	Accounting Metric	Code	Information Location
Workforce Health and Safety	(1) Total recordable incident rate (TRIR), (2) fatality rate, (3) near miss frequency rate (NMFR), (4) total vehicle incident rate (TVIR), and (5) average hours of health, safety, and emergency response training for (a) full-time employees, (b) contract employees, and (c) short-service employees	EM-SV-320a.1	2023 Sustainability Report, Pages 50 - 52, and 69 HSE
	Description of management systems used to integrate a culture of safety throughout the value chain and project lifestyle	EM-SV-320a.2	2023 Sustainability Report, Pages 50 - 52 HSE
	Number of road accidents and incidents	EM-SV-320a.3	2023 Sustainability Report, Page 69

ACTIVITY METRIC

Topic	Code	Information Location
Number of active rig sites	EM-SV-000.A	Not Reported
Number of active well sites	EM-SV-000.B	Not Reported
Total amount of drilling performed	EM-SV-000.C	Not Reported
Total number of hours worked by all employees	EM-SV-000.D	2023 Sustainability Report, Page 69

GRI

This report reference SLB's 2023 Form 10-K and 2024 Proxy Statement. These can both be found [here](#).

GRI CONTENT INDEX

Statement of use	SLB has reported the information cited in this GRI content index for the period January 1, 2023 through December 31, 2023 with reference to the GRI Standards and all sites under SLB operational control, unless otherwise noted.
GRI Standard used	GRI 1: Foundation 2021 and GRI 11: Oil and Gas Sector

GENERAL DISCLOSURES

Disclosure	Disclosure Description	Disclosure Location, Reference or Data
GRI 2: General Disclosures		
2-1	Organizational details	Schlumberger N.V. (Schlumberger Limited), 2023 Form 10-K
2-2	Entities included in the organization's sustainability reporting	2023 Form 10-K, Exhibit 21 and Consolidated Financial Statements
2-3	Reporting period, frequency, and contact	January 1 - December 31, 2023 unless otherwise noted, published February 23, 2024 and reported annually sustainability@slb.com
2-4	Restatements of information	2023 Sustainability Report, Pages 70, footnotes
2-5	External assurance	Report of Independent Accountants, dated February 23, 2024
2-6	Activities, value chain, and other business relationships	2023 Sustainability Report, Pages 3, 45 - 49, and 70 2023 Form 10-K , Pages 3 - 8
2-7	Employees	2023 Sustainability Report, Pages 21 - 30, and 69 - 70
2-8	Workers who are not employees	2023 Sustainability Report, Pages 21 - 30, and 69 - 70
2-9	Governance structure and composition	2023 Sustainability Report, Page 42 2024 Proxy Statement , Pages 8 and 11 - 26 Corporate Governance

Disclosure	Disclosure Description	Disclosure Location, Reference or Data
2-10	Nomination and selection of the highest governance body	2024 Proxy Statement , Pages 12 - 19 and 22 - 24
2-11	Chair of the highest governance body	2024 Proxy Statement, Pages 15 and 19
2-12	Role of the highest governance body in overseeing the management of impacts	2023 Sustainability Report, Pages 42 - 44 Sustainability Governance Ethics & Compliance 2024 Proxy , Pages 20 - 21
2-13	Delegation of responsibility for managing impacts	2023 Sustainability Report , Page 42 Sustainability Governance TCFD
2-14	Role of the highest governance body in sustainability reporting	2023 Sustainability Report, Page 42 Sustainability Governance
2-15	Conflicts of interest	Ethics & Compliance Conflicts of Interest Policy
2-16	Communication of critical concerns	2023 Sustainability Report, Pages 43 - 44 Ethics & Compliance
2-17	Collective knowledge of the highest governance body	2024 Proxy Statement, Pages 12 - 19
2-18	Evaluation of the performance of the highest governance body	2023 Sustainability Report, Page 42 2024 Proxy Statement, Page 24
2-19	Remuneration Policies	2024 Proxy Statement, Pages 31 - 62
2-20	Process to determine remuneration	2024 Proxy Statement, Pages 31 - 62
2-21	Annual total compensation ratio	2024 Proxy Statement , page 59

GRI continued

SECTOR STANDARDS

Disclosure	Disclosure Description	Disclosure Location, Reference or Data
GRI 2: General Disclosures continued		
2-22	Statement on sustainable development strategy	2023 Sustainability Report, Pages 19 - 20 and 42
2-23	Policy commitments	2023 Sustainability Report, Pages 24 - 25
2-24	Embedding policy commitments	2023 Sustainability Report, Pages 43 - 44 and 47 - 49 Ethics & Compliance
2-25	Processes to remediate negative impacts	2023 Sustainability Report, Pages 43 - 44 Ethics & Compliance
2-26	Mechanisms for seeking advice and raising concerns	2023 Sustainability Report, Pages 43 - 44 Ethics & Compliance
2-27	Compliance with laws and regulations	2023 Form 10-K, Pages 15 and 47
2-28	Membership associations	2023 Sustainability Report Pages 45 - 46 CDP C12.3b
2-29	Approach to stakeholder engagement	2023 Sustainability Report, Pages 45 - 46 2024 Proxy Statement, Pages, 22, 35 - 36
2-30	Collective bargaining agreements	2023 Sustainability Report, Page 70
GRI 3: Material Topics		
3-1	Process to determine material topics	2024 Proxy Statement, Pages 20 - 21
3-2	List of material topics	2023 Form 10-K, Pages 10 - 15, TCFD
3-3	Management of material topics	2024 Proxy Statement, Pages 20 - 21
GRI 201: Economic Performance 2016		
201-1	Direct economic value generated and distributed	2023 Form 10-K
201-2	Financial implications and other risks and opportunities due to climate change	Form 10-K , Pages 10 - 15 CDP C2
GRI 202: Market Presence 2016		
202-2	Proportion of senior management hired from the local community	2023 Sustainability Report, Page 70
GRI 203: Indirect Economic Impacts 2016		
203-1	Infrastructure investments and services supported	Data not available
203-2	Significant indirect economic impacts	Data not available

Disclosure	Disclosure Description	Disclosure Location, Reference or Data
GRI 204: Procurement Practices 2016		
204-1	Proportion of spending on local suppliers	2023 Sustainability Report, Page 70
GRI 205: Anti-corruption 2016		
205-1	Operations assessed for risks related to corruption	2023 Sustainability Report, Pages, 24 and 43 - 44 Ethics & Compliance Human Rights
205-2	Communication and training about anti-corruption policies and procedures	2023 Sustainability Report, Pages 43 - 44 and 69 Ethics & Compliance
205-3	Confirmed incidents of corruption and actions taken	Data not disclosed due to confidentiality 2023 Sustainability Report 43 - 44
GRI 206: Anti-competitive Behavior 2016		
206-1	Legal actions for anti-competitive behavior, anti-trust, and monopoly practices	2023 Form 10-K
GRI 207: Tax 2019		
207-1	Approach to tax	Approach to Tax
207-2	Tax governance, control, and risk management	Corporate Governance Approach to Tax
207-3	Stakeholder engagement and management of concerns related to tax	Approach to Tax
207-4	Country-by-country reporting	Data not disclosed due to confidentiality
GRI 302: Energy 2016		
302-1	Energy consumption within the organization	2023 Sustainability Report, Page 68
302-2	Energy consumption outside of the organization	2023 Sustainability Report, Page 68
302-3	Energy intensity	0.225 MWh per thousand US dollars revenue
302-4	Reduction of energy consumption	2023 Sustainability Report, Page 68
GRI 303: Water and Effluents 2018		
303-1	Interactions with water as a shared resource	2023 Sustainability Report, Pages 34 - 37
303-2	Management of water discharge-related impacts	2023 Sustainability Report, Pages 34 - 37
303-3	Water withdrawal	2023 Sustainability Report, Page 69
303-4	Water discharge	Data not reported
303-5	Water consumption	2023 Sustainability Report, Page 69

GRI continued

SECTOR STANDARDS CONTINUED

Disclosure	Disclosure Description	Disclosure Location, Reference or Data
GRI 304: Biodiversity 2016		
304-1	Operational sites owned, leased, managed in, or adjacent to, protected areas and areas of high biodiversity value outside protected areas	2023 Sustainability Report, Page 32
304-2	Significant impacts of activities, products, and services on biodiversity	2023 Sustainability Report, Pages 31 - 33
304-3	Habitats protected or restored	2023 Sustainability Report, Pages 32 - 33
304-4	IUCN Red List species and national conservation list species with habitats in areas affected by operations	Data not available
GRI 305: Emissions 2016		
305-1	Direct (Scope 1) GHG emissions	2023 Sustainability Report, Page 68
305-2	Energy indirect (Scope 2) GHG emissions	2023 Sustainability Report, Page 68
305-3	Other indirect (Scope 3) GHG emissions	2023 Sustainability Report, Page 68
305-4	GHG emissions intensity	2023 Sustainability Report, Pages 11 and 68
305-5	Reduction of GHG emissions	2023 Sustainability Report, Pages 8 and 68
305-6	Emissions of ozone-depleting substances	Data not available
305-7	Nitrogen oxides (NOx), sulfur oxides (SOx), and other significant air emissions	Data not available
GRI 306: Waste 2020		
306-1	Waste generation and significant waste-related impacts	2023 Sustainability Report, Pages 38 - 41
306-2	Management of significant waste-related impacts	2023 Sustainability Report, Pages 38 - 41
306-3	Waste generated	2023 Sustainability Report, Page 69
306-4	Waste diverted from disposal	2023 Sustainability Report, Pages 38 - 41 and 69
306-5	Waste directed to disposal	2023 Sustainability Report, Page 69
GRI 306: Effluents and Waste 2016		
306-3	Significant spills	2023 Sustainability Report, Page 69
GRI 308: Supplier Environmental Assessment 2016		
308-1	New suppliers that were screened using environmental criteria	2023 Sustainability Report, Pages 47 - 49 and 70
308-2	Negative environmental impacts in the supply chain and action taken	Data not disclosed due to confidentiality

Disclosure	Disclosure Description	Disclosure Location, Reference or Data
GRI 401: Employment 2016		
401-1	New employee hires and employee turnover	2023 Sustainability Report, Page 70
401-2	Benefits provided to full-time employees that are not provided to temporary or part-time employees	Data not disclosed
401-3	Parental leave	Data not disclosed
GRI 403: Occupational Health and Safety 2018		
403-1	Occupational health and safety management system	2023 Sustainability Report, Pages 50 - 52
403-2	Hazard identification, risk assessment, and incident investigation	2023 Sustainability Report, Pages 50 - 52
403-3	Occupational health services	HSE
403-4	Worker participation, consultation, and communication on occupational health and safety	HSE
403-5	Worker training on occupational health and safety	2023 Sustainability Report, Pages 50 - 52 and 69 HSE
403-6	Promotion of worker health	2023 Sustainability Report, Pages 50 - 52 HSE
403-7	Prevention and mitigation of occupational health and safety impacts directly linked by business relationships	2023 Sustainability Report, Pages 50 - 52 HSE
403-8	Workers covered by an occupational health and safety management system	2023 Sustainability Report, Pages 50 - 52 and 69 HSE
403-9	Work-related injuries	2023 Sustainability Report, Page 69
403-10	Work related ill health	2023 Sustainability Report, Page 69
GRI 404: Training and Education 2016		
404-1	Average hours of training per year per employee	2023 Sustainability Report, Page 69
404-2	Programs for upgrading employee skills and transition	2023 Sustainability Report, Pages 26 and 69 Learning and Development
404-3	Percentage of employees receiving regular performance and career development reviews	2023 Sustainability Report, Page 70
GRI 405: Diversity and Equal Opportunity 2016		
405-1	Diversity of governance bodies and employees	2023 Sustainability Report, Page 70
405-2	Ratio of basic salary and remuneration	Data not available, but see gender pay gap reports here

GRI continued

Disclosure	Disclosure Description	Disclosure Location, Reference or Data
GRI 406: Non-discrimination 2016		
406-1	Incidents of discrimination and corrective actions taken	Data not disclosed due to confidentiality
GRI 407: Freedom of Association and Collective Bargaining 2016		
407-1	Operations and suppliers in which the right to freedom of association and collective bargaining may be at risk	Data not disclosed due to confidentiality Human Rights We prohibit any use or contracting, directly or indirectly, of slavery, human trafficking, child labor, or any form of forced labor.
GRI 408: Child Labor		
408-1	Operations and suppliers at significant risk for incidents of child labor	Data not disclosed due to confidentiality Human Rights
GRI 409: Forced or Compulsory Labor 2016		
409-1	Operations and suppliers at significant risk for incidents of forced or compulsory labor	Data not disclosed due to confidentiality Human Rights
GRI 410: Security Practices 2016		
410-1	Security personnel trained in human rights policies or procedures	Human Rights
GRI 411: Rights of indigenous peoples		
411-1	Incidents of violations involving rights of indigenous peoples	Data not disclosed due to confidentiality

Disclosure	Disclosure Description	Disclosure Location, Reference or Data
GRI 413: Local Communities 2016		
413-1	Operations with local community engagement, impact assessments, and development programs	Data not available
413-2	Operations with significant actual and potential negative impacts on local communities	Data not available
GRI 414: Supplier Social Assessment 2016		
414-1	New suppliers that were screened using social criteria	2023 Sustainability Report, Pages 24 - 25
414-2	Negative social impacts in the supply chain and actions taken	2023 Sustainability Report, Pages 25 and 70
GRI 415: Public Policy 2016		
415-1	Political contributions	2023 Sustainability Report, Page 46

TCFD

This report reference SLB’s 2023 Form 10-K and 2024 Proxy Statement. These can both be found [here](#).

Governance

Disclose the organization’s governance around climate-related risks and opportunities.

TCFD Index	Disclosure	Reference(s)	Description
TCFD A-a	Describe the Board’s oversight of climate-related risks and opportunities.	CDP – C1.1 2023 Sustainability Report, Page 42 2024 Proxy Statement, Pages 20 - 21	<p>Our Board of Directors oversees the long-term health and viability of our business, including the company’s long- and short-term strategy, vision, and risk profile. The Board also oversees the company’s enterprise risk management process and reviews major risks facing the company, including acute and chronic climate risks and energy transition risks.</p> <p>The Board and its committees oversee the performance and management of various environmental, social, nature, and other sustainability issues, including our energy transition strategy, emissions reduction targets, climate change impact, sustainability reporting, workforce health and safety, human rights, workforce diversity, biodiversity, water resources, and ethics and compliance. For example:</p> <ul style="list-style-type: none"> → The Board oversees SLB’s long- and short-term strategy, including monitoring portfolio advancements that focus on decarbonizing our Core businesses—such as our Transition Technologies and emissions monitoring portfolios—as well as our SLB New Energy investments in low-carbon and carbon-neutral energy technologies. The Board oversees SLB’s roadmap to reach its 2050 net zero commitment that is inclusive of Scope 3 emissions and includes interim Scope 1, 2, and 3 emissions reduction milestones. → The Board also oversees SLB’s enterprise risk management process, and reviews major risks facing SLB, including geopolitical risks, acute and chronic climate risks, and energy transition risks. → The Nominating and Governance Committee oversees our sustainability programs, initiatives, and activities, including the three priorities of our sustainability strategy: climate action, nature, and people. The committee receives regular updates from senior management on the progress we are making, toward achieving a low-carbon future. This Committee also reviews the effectiveness of our human rights program and the effectiveness of SLB’s Ethics and Compliance program, including our Code of Conduct, and all significant compliance allegations. → The New Energy and Innovation Committee provides insights on the growth potential, maturity, and viability of SLB’s targeted New Energy business sectors, and validates the sustainability impacts of growth opportunities. → The Board’s other committees oversee sustainability-related topics within their respective areas of responsibility, such as the incorporation of sustainability and diversity metrics into our short-term incentive compensation programs (Compensation); the conduct of sustainability-related reviews by our internal audit team (Audit); operational risks such as cybersecurity (Audit); and the disclosure of ESG risks (Audit and Nominating and Governance, jointly).
TCFD A-b	Describe management’s role in assessing and managing climate-related risks and opportunities	CDP – C1.2 2023 Sustainability Report, Page 42 2024 Proxy Statement, Page 20 - 21	<p>Our senior management team is responsible for the day-to-day management and mitigation of climate and transition risk, including identifying, assessing, monitoring, and managing the major risks to SLB through our enterprise risk management process and (described below in the “Risk Management” section of this report) implementing effective risk mitigation measures, response plans, and controls integrating risk analysis into business decisions and performance objectives.</p> <p>Our Chief Strategy & Sustainability Officer (CSSO), who reports to the CEO, oversees our corporate strategy, sustainability, and marketing activities. This position demonstrates how sustainability is at the core of our corporate strategy. The CSSO was involved in the launch of SLB’s net zero commitment and short-term, mid-term, and long-term targets spanning Scope 1, 2, and 3 emissions. Scenario analyses, including scenarios associated with climate change and the energy transition, are the responsibility of the CSSO. The VP of Sustainability, who reports to the CSSO, is directly responsible for social and environmental sustainability in the company and engages with SLB leadership, employees, investors, and customers on sustainability topics, including climate-related issues.</p> <p>The CEO and Chief Financial Officer annually approve the capital investment budget, including investments in technology to reduce emissions in oil and gas and low carbon businesses in the SLB New Energy portfolio.</p> <p>Our CSSO and our Chief Legal Officer jointly oversee the company’s enterprise risk management program.</p>

TCFD continued

Strategy

Disclose the actual and potential impacts of climate-related risks and opportunities on the organization’s businesses, strategy, and financial planning where such information is material.

TCFD Index	Disclosure	Reference(s)	Description
TCFD B-a	Describe the climate-related risks and opportunities the organization has identified over the short, medium, and long-term.	CDP – C2.1, C2.2, C2.3, and C2.4 2023 Form 10-K, Pages 10 - 14	<p>Our corporate strategy around climate is described in the “Climate Action” section of our 2023 Sustainability Report and is supported by an updated ESG risk assessment in 2023. Our focus areas include achieving net zero emissions by 2050, decarbonizing oil and gas operations for SLB and our customers, and investing in New Energy and transition opportunities. Our strategy to achieve our 2050 net zero ambition involves three key components: reducing operational emissions, reducing customer emissions that occur while using our technology, and taking carbon-negative actions of sufficient scale to offset any residual operational and technology emissions we may have in 2050. We will reduce emissions from our operations through utility efficiency and use of renewable energy and hybrid vehicles. We will reduce customer emissions with our Transition Technologies™ portfolio. For emissions that cannot be reduced, rather than relying on traditional offsets, we will rely on our carbon-negative actions that are technology-centric, where we can play a role, such as through our SLB New Energy portfolio described in our 2023 Sustainability Report under “Climate Action”—New Energy & Transition Opportunities.</p> <p>A key aspect of our climate action strategy is managing physical climate and transition risks and opportunities. We take a data-centric, scenario-based approach, and we use TCFD, GRI, and SASB as disclosure frameworks and methodology guides. Because we realize that climate change and energy transition will impact our business, understanding and managing these risks and opportunities provides a competitive advantage that will help us be more resilient to potential risks and stay ahead of the competition.</p> <p>To deliver on our strategy, we assess, monitor, and manage risks and opportunities based on the following time horizons:</p> <ul style="list-style-type: none"> → Short term: We assess geopolitical risks and risks related to unpredictable weather patterns—including cyclones, hurricanes, and tropical storms that have the potential to affect our bases in coastal areas—on a one- to three-year timeframe. → Medium term: We consider capital expenditures and operational planning, including development of new technologies that have the potential to reduce our customers’ GHG emissions, over a three- to ten-year timeframe. → Long-term: The Board and senior management take a longer view in considering strategic planning, including climate-related risks and opportunities that have the potential to negatively or positively affect our business over the medium term (three to ten years) and long-term (ten to 20 years). Included in long-term risks are energy transition and climate change. <p>Some of the key risk types that we assess, monitor, and manage as part of our climate-related risk assessments are as follows:</p> <ul style="list-style-type: none"> → Current regulatory risks: We are committed to complying with existing regulations in every country in which we work. SLB management has implemented strategies to reduce fuel consumption for our largest sources of emissions, such as pumps and fleet vehicles. Additionally, we continue to monitor GHG emission reporting requirements in the countries where we operate. → Emerging regulatory risks: Emerging regulation spans all three time horizons discussed above. Various international, federal, and state agencies are currently developing climate-related legislation and regulations intended to reduce GHG emissions and regulations related to emissions disclosure. As an example, the US Environmental Protection Agency has taken steps to regulate GHGs via the Clean Air Act as well as proposing additional reporting rules focused on oil and gas industry operations. The US Securities and Exchange Commission has also proposed detailed climate risk and GHG emissions disclosure rules. We monitor these changes closely through our legal, compliance, corporate governance, and environmental teams. We evaluate the likelihood and severity of changes in regulatory requirements and political trends related to climate change and the energy transition through risk assessments and risk mapping in line with the recommendations of TCFD. <p>As an action related to emerging climate risks, in 2023 to operationalize our net zero commitment and motivate our employees to take climate action, we introduced company-wide sustainability key performance objectives (KPOs) focused on Scope 1, 2, and/or 3 emissions intensity reduction. This was accompanied by an engagement campaign, and the launch of our ‘Understanding SLB Emissions and Decarbonization Pathways’ closing online training program. In addition, our executive leadership team shares a Scope 3 intensity-reduction KPO.</p> → Technology risks: We believe that increasing customer focus on emerging legislation and sustainability priorities could lead to a shift in customer behavior and a decrease in demand for certain products and services and increased demand for others. We engage with customers to anticipate these shifts, which generally occur in the medium- to long-term time horizons. In parallel, we work with our customers to find new opportunities to mitigate potential negative environmental and social impacts of oil and gas operations. SLB’s Transition Technologies portfolio includes 34 products and was estimated to have helped our customers avoid more than 830,000 metric tons of CO₂e in GHG emissions throughout 2023. With a focus on reducing methane and routine flaring, we launched two new sensors to the market, complementing our digital methane platform, technology partnerships and consultancy capabilities.
TCFD B-b	Describe the impact of climate-related risks and opportunities on the organization’s businesses, strategy, and financial planning	CDP – C2.3, C2.4, C3.1, C3.2, C3.3, and C3.4 2023 Form 10-K, Pages 10 - 14	<p>To deliver on our strategy, we assess, monitor, and manage risks and opportunities based on the following time horizons:</p> <ul style="list-style-type: none"> → Short term: We assess geopolitical risks and risks related to unpredictable weather patterns—including cyclones, hurricanes, and tropical storms that have the potential to affect our bases in coastal areas—on a one- to three-year timeframe. → Medium term: We consider capital expenditures and operational planning, including development of new technologies that have the potential to reduce our customers’ GHG emissions, over a three- to ten-year timeframe. → Long-term: The Board and senior management take a longer view in considering strategic planning, including climate-related risks and opportunities that have the potential to negatively or positively affect our business over the medium term (three to ten years) and long-term (ten to 20 years). Included in long-term risks are energy transition and climate change. <p>Some of the key risk types that we assess, monitor, and manage as part of our climate-related risk assessments are as follows:</p> <ul style="list-style-type: none"> → Current regulatory risks: We are committed to complying with existing regulations in every country in which we work. SLB management has implemented strategies to reduce fuel consumption for our largest sources of emissions, such as pumps and fleet vehicles. Additionally, we continue to monitor GHG emission reporting requirements in the countries where we operate. → Emerging regulatory risks: Emerging regulation spans all three time horizons discussed above. Various international, federal, and state agencies are currently developing climate-related legislation and regulations intended to reduce GHG emissions and regulations related to emissions disclosure. As an example, the US Environmental Protection Agency has taken steps to regulate GHGs via the Clean Air Act as well as proposing additional reporting rules focused on oil and gas industry operations. The US Securities and Exchange Commission has also proposed detailed climate risk and GHG emissions disclosure rules. We monitor these changes closely through our legal, compliance, corporate governance, and environmental teams. We evaluate the likelihood and severity of changes in regulatory requirements and political trends related to climate change and the energy transition through risk assessments and risk mapping in line with the recommendations of TCFD. <p>As an action related to emerging climate risks, in 2023 to operationalize our net zero commitment and motivate our employees to take climate action, we introduced company-wide sustainability key performance objectives (KPOs) focused on Scope 1, 2, and/or 3 emissions intensity reduction. This was accompanied by an engagement campaign, and the launch of our ‘Understanding SLB Emissions and Decarbonization Pathways’ closing online training program. In addition, our executive leadership team shares a Scope 3 intensity-reduction KPO.</p> → Technology risks: We believe that increasing customer focus on emerging legislation and sustainability priorities could lead to a shift in customer behavior and a decrease in demand for certain products and services and increased demand for others. We engage with customers to anticipate these shifts, which generally occur in the medium- to long-term time horizons. In parallel, we work with our customers to find new opportunities to mitigate potential negative environmental and social impacts of oil and gas operations. SLB’s Transition Technologies portfolio includes 34 products and was estimated to have helped our customers avoid more than 830,000 metric tons of CO₂e in GHG emissions throughout 2023. With a focus on reducing methane and routine flaring, we launched two new sensors to the market, complementing our digital methane platform, technology partnerships and consultancy capabilities.

TCFD continued

Strategy continued

TCFD Index	Disclosure	Reference(s)	Description
B-a and B-b (continued)			<ul style="list-style-type: none"> → Legal risks: Legal risks and liability across multiple lenses (including, but not limited to climate-related issues) are considered as part of the financial severity assessment of our enterprise risk management process. This is informed by both current and emerging regulation as well as a scheduled quarterly review, internally and with the Board’s Nominating and Governance Committee, of compliance incidents and incident trends. → Market risks: As a business-to-business company providing services to industry operators, potential changes in a portion of our revenue are directly tied to the market outlook of oil and gas operators, and therefore indirectly tied to market demand for fuels and other petroleum products. We routinely monitor oil and gas industry operations and investment activity to determine the market outlook for the energy services industry and how our business will be impacted. For example, a market risk we review regularly is the International Energy Agency’s (IEA) research outlining the energy mix and their market predictions between now and 2050. → Reputational risks: In the context of climate, reputational risk exists across all three time horizons discussed in this section. It presents itself in various ways, including but not limited to the following: <ul style="list-style-type: none"> – Workforce motivation and engagement risk: Because corporate sustainability efforts, including the management of climate-related issues, increasingly affect workforce engagement, we incorporated into our annual employee engagement survey a question to measure workforce perception of our corporate sustainability efforts. Employee respondents to the survey in 2023 scored our corporate sustainability efforts higher than, on average, other companies, based on similar questions asked in other companies’ internal surveys. We also include content related to our climate action strategy in recruiting and onboarding materials. In addition, we introduced several sustainability training modules for employees covering such topics as circular economy, understanding emissions, human rights, and water stewardship as part of our Sustainability Upskilling program. – Media coverage and public perception risk: Stakeholder engagement, monitoring and reporting trends, and comprehensive governance are the primary vehicles for managing this risk. Transparency through our nonfinancial disclosures, guided by frameworks like TCFD, GRI, and SASB, are another way to mitigate this risk. – Well integrity risk: Extreme weather can potentially introduce well integrity risk, which in turn is a risk to reputation. We have addressed well integrity risk, regardless of the root cause, by developing a Well Integrity Barrier Standard containing ten critical requirements that must be followed by all employees and contractors of SLB. Development of this standard was a company-wide initiative to raise awareness and to impose mandatory rules defining the minimum requirements in training, certification, and knowledge of the barriers we provide.
TCFD B-c	Describe the resilience of the organization’s strategy, taking into consideration different climate related scenarios, including a 2 degrees C or lower scenario.	CDP – C3.2	<p>Climate-related scenarios are an integral part of our scenarios-based portfolio strategy. We review different scenarios to evaluate our business resilience and confirm our portfolio’s alignment with our energy transition ambitions related to those scenarios. For example, both 2DS and IEA NZE were useful in understanding the role that CCS will play in the path to net zero. Although we have been in the carbon capture business for more than two decades, the scenarios gave us confidence that the potential addressable market in carbon capture warranted continued investment and integration of that business into our SLB New Energy portfolio. IHS and Rystad both had scenarios that informed our view of regional and local distribution of the energy mix and therefore influenced our specific regional technology strategies. Reviewing scenarios with a 2040 time horizon against those with a 2050 time horizon helped inform certain of our long-term portfolio mix decisions.</p> <p>We will continue to use scenarios to inform our strategy and financial planning, including those that offer a range of time horizons, ambition with respect to transition, and varied perspectives to help us better understand the risks and opportunities that climate change and the energy transition present. We also will continue to review the accuracy of our scenario predictions with the goal of working from best available predictive information regarding the coming decades. All of the scenarios we used in building our strategy allocate some share of the energy mix to oil and gas in the coming decades. Our strategy considers that there is a wide range of possibilities with respect to the future energy mix and the pace of energy transition and, as such, our strategy addresses opportunities across multiple time horizons. Regardless of the contribution of oil and gas to the energy mix, SLB recognizes the need to reduce the carbon footprint of oil and gas operations, and therefore our strategy considers that as well.</p>

TCFD continued

Risk Management

Risk Management – Disclose how the organization identifies, assesses, and manages climate-related risks.

TCFD Index	Disclosure	Reference(s)	Description
TCFD C-a	Describe the organization’s processes for identifying and assessing climate-related risks	CDP – C2.1 and C2.2 2024 Proxy Statement, Pages 20 - 21	Our senior management team has developed a comprehensive strategic planning and enterprise risk management process for identifying, assessing, and managing risk. Through this process, we identify key risks through a corporate-level risk mapping exercise, which involves the CEO and other members of senior management, along with a bottom-up operational (field-level) risk assessment by SLB’s various geographies, businesses, and functions. From time to time, the process also includes third-party assessment, external risk surveys, and facilitated workshops with SLB executives. Our executive leadership team has established an enterprise risk management committee to oversee this risk identification process and to monitor the implementation of mitigation processes. Our executive leadership team updates the Board at least annually as risks that could impact the implementation of SLB’s strategy are identified or evolve. In 2023, to enhance our governance framework, a mapping of our operational risks was completed by all of our regions and divisions. The 2023 mapping considered emerging and new risks to align with our sustainability priorities.
TCFD C-b	Describe the organization’s processes for managing climate-related risks	CDP – C2.1 and C2.2 2024 Proxy Statement, Pages 20 - 21	We believe that our comprehensive risk assessment program is reasonably designed to identify and manage climate change related enterprise-wide risks that have the potential to significantly affect our businesses over the short, medium, and longer terms. Our risk assessments cover exposures to both physical and transition climate-related risks and their respective financial impact. The climate-related risks we routinely monitor as part of our enterprise risk management process include potential loss of containment and well control, country-specific legislation and regulations, environmental compliance, financial risk associated with climate change, perception of industry due to climate change dialogue, and extreme weather. At a corporate level, business risks related to climate change are identified based on input from a variety of internal and external sources, including local risk assessments, country-specific climate assessments aligned with TCFD recommendations, and feedback from customers, investors, the Board, and other stakeholders. Identified enterprise-level risks are then developed into various scenarios, guided by subject matter experts, and these scenarios are modeled to assess potential financial impacts.
TCFD C-c	Describe how processes for identifying, assessing, and managing climate-related risks are integrated into the organization’s overall risk management	CDP – C2.1 and C2.2 2024 Proxy Statement, Pages 20 - 21	In the case of acute physical risks, crisis management scenarios are created and tested in desktop exercises at the local and corporate level by the respective management teams. Enterprise-level risks are also included in our operational risk maps, which help to identify and assess potential threats to the mid- to long-term strategic objectives. A risk owner is assigned from among senior management for each enterprise-level risk to manage the risk management and mitigation plans. Oversight of the management plan for each enterprise level risk is assigned to the Board or Board Committee as appropriate. As an example, certain potential impacts regarding new regulations restricting oil and gas have been determined to be an enterprise-level risk. The Chief Legal Officer is the risk owner, and the Nominating and Governance Committee oversees the Company’s comprehensive monitoring, prevention, and response capabilities. In addition, Board Committees with specific oversight responsibilities receive more frequent updates related to those specific risks. These risks are monitored and embedded into the business planning cycle. Risks are scored on likelihood, severity, time horizon, and financial impact. Where applicable, management objectives include management and mitigation of risk.

TCFD continued

Risk Management continued

Risk Management – Disclose how the organization identifies, assesses, and manages climate-related risks.

TCFD Index	Disclosure	Reference(s)	Description
TCFD C-c continued	Describe how processes for identifying, assessing, and managing climate-related risks are integrated into the organization’s overall risk management continued	CDP – C2.1 and C2.2 continued	<p>Climate Risk Management</p> <p>Our business has been, and in the future will be, affected by severe weather events in areas where we operate, which could materially affect our operations and financial results. Extreme weather conditions such as hurricanes, flooding, landslides, and heat waves have in the past resulted in, and may in the future result in, the evacuation of personnel, stoppage of services and activity disruptions at our facilities, in our supply chain, or at well sites, or result in disruptions of our customers’ operations. Particularly severe weather events affecting platforms or structures may result in a suspension of activities. In addition, acute or chronic physical impacts of climate change, such as sea level rise, coastal storm surge, inland flooding from intense rainfall, and hurricane-strength winds may damage our facilities. Any such extreme weather events may result in increased operating costs or decreases in revenue.</p> <p>Country-level climate risk assessments provide a practical way to understand climate-related risks and common issues across our organization. For these assessments, we work with a leading sustainability consultant to review the potential impact of climate issues on our direct operations. Climate-related risks (physical and financial, including transition risks) are assessed using scenario-based analysis. While there are country-specific concerns, some commonalities across geographies are:</p> <ul style="list-style-type: none"> → acute physical risks associated with extreme weather, such as storm surges, droughts, heat waves, flooding, rain, and snow → chronic physical risks, such as the potential impact of sea-level rise on our global footprint, water availability, and protected marine life → transition risks, such as policy and legal risks, the impact of a carbon tax on SLB and our customers, the cost of electrifying our operations, and the cost of adapting our technology portfolio to changing customer preference. <p>We have also completed several global climate risk assessment projects, including projects relating to the risks of coastal flooding from sea level rise, physical risks from more severe and frequent storms, and the regulatory risks of carbon taxation. In 2023, we completed a comprehensive biodiversity risk assessment and expanded on our 2022 water risk assessment.</p> <p>We review acute physical risks associated with extreme weather in areas susceptible to increased severity and frequency of extreme weather related to water (e.g., hurricane, excessive rain, or flooding) or increased severity and frequency of extreme heat. Those variances may impact our business by causing extreme changes in precipitation patterns that may result in flooding, changes in road or wellsite conditions, or damage to facilities. This may result in increased operating costs or decreases in revenue through disruptions at our facilities, in our supply chain, or at wellsites; equipment damage and repair requirements; and increased insurance premiums.</p> <p>To manage extreme weather risks, we work with a third party loss prevention firm to conduct site visits, assess potential risks to our facilities, and propose mitigating actions. We also consider the potential impact of sea level rise on our global footprint. Additionally, SLB has business continuity and crisis management processes in place to mitigate potential disruptions caused by extreme weather events.</p>

TCFD continued

Risk Management continued

TCFD Index	Disclosure	Reference(s)	Description
TCFD C-a, C-b, and C-c		CDP – C2.1 and C2.2 continued	<p>Transition Risk Management</p> <p>Continuing political and social attention to the issue of climate change has resulted in both existing and proposed international agreements and national, regional, and local legislation and regulatory measures to limit GHG emissions. The implementation of these agreements, including the Paris Agreement, the Europe Climate Law, and other existing or future regulatory mandates, may adversely affect the demand for our products and services, impose taxes on us or our customers, require us or our customers to reduce GHG emissions from our technologies or operations, or accelerate the obsolescence of our products or services. In addition, increasing attention to the risks of climate change has resulted in an increased possibility of litigation or investigations brought by public and private entities against oil and gas companies in connection with their GHG emissions. As a result, we or our customers may become subject to court orders compelling a reduction of GHG emissions or requiring mitigation of the effects of climate change.</p> <p>There is also increased focus by our customers, investors, and other stakeholders on climate change, sustainability, and energy transition matters. Actions to address these concerns or negative perceptions of our industry or fossil fuel products and their relationship to the environment have led to initiatives to conserve energy and promote the use of alternative energy sources, which may reduce the demand for and production of oil and gas in areas of the world where our customers operate, and thus reduce future demand for our products and services. In addition, initiatives by investors and financial institutions to limit funding to companies in fossil fuel-related industries may adversely affect our liquidity or access to capital. Any of these initiatives may, in turn, adversely affect our financial condition, results of operations, and cash flows.</p> <p>Our business also faces increased scrutiny from certain investors and other stakeholders related to our sustainability activities, including the goals, targets, and objectives that we announce, and our methodologies and timelines for pursuing them. If our sustainability practices do not meet investor or other stakeholder expectations and standards, which continue to evolve, our reputation, our ability to attract or retain employees, and our attractiveness as an investment or business partner could be negatively affected. Similarly, our failure or perceived failure to pursue or fulfill our sustainability focused goals, targets, and objectives, to comply with ethical, environmental, or other standards, regulations, or expectations, or to satisfy various reporting standards with respect to these matters, within the timelines we announce, or at all, could adversely affect our business or reputation, as well as expose us to government enforcement actions and private litigation.</p> <p>Our Transition Technologies portfolio and the SLB New Energy business offers a strategic response to the management of energy transition risks, as discussed in the “Climate Action” section of our 2023 Sustainability Report. We continue to regularly map and report our progress towards our emission reduction targets with both internal and third-party resources to understand our progress and potential opportunities.</p>

TCFD continued

Metrics & Targets

Metrics & Targets – Disclose how the organization identifies, assesses, and manages climate-related risks.

TCFD Index	Disclosure	Reference(s)	Description
TCFD D-a	Disclose the metrics used by the organization to assess climate-related risks and opportunities in line with its strategy and risk management process	CDP – C2.1, C2.1a, C2.1b, C2.2, C2.2a	Our climate action strategy is underpinned by our commitment to achieve net zero emissions by 2050, with interim targets aligned with science-based methodology and the 1.5 °C target of the Paris Agreement and track our progress. To achieve these goals across all three scopes of emissions, we have implemented a detailed roadmap of emission reduction actions within each Division and geography and across the short-, medium-, and long-term time horizons. As our net zero commitment is inclusive of our value chain, we are also working with our suppliers to help them reduce their emissions footprint. Since 2019, SLB has tracked GHG emissions, prioritizing transparent data collection and real-time monitoring. This ongoing record-keeping informs our sustainability strategy, in order to implement effective GHG emission reduction efforts. We also, annually, commission an external third party to perform attest procedures with respect to certain GHG emissions. Emissions calculations are based on the principles and guidance established in The Greenhouse Gas Protocol: A Corporate Accounting and Reporting Standard (Revised Edition) to calculate our annual CO ₂ e emissions. As part of that process, we apply emissions factors and global warming potential (GWP) factors to energy consumption data to derive CO ₂ e values. The GWP factors are taken from the IPCC Fifth Assessment Report (AR5 – 20 year and 100 year).
TCFD D-b	Disclose Scope 1, Scope 2, and if appropriate, Scope 3 GHG emissions and the related risks.	CDP – C2.1, C2.2 Performance Data Table Page 68	
TCFD D-c	Describe the targets used by the organizations to manage climate-related risks and opportunities and performance against targets.	CDP – C2.1, C2.2 2023 Sustainability Report Pages 8 - 20 and 68	

2023 Performance Data

We commissioned an external third party to perform attest procedures with respect to certain greenhouse gas emissions, health and safety, and site activity metrics for the year ended December 31, 2023 and certain water and waste metrics for the period from October 1, 2022 to September 30, 2023.



Full details and data methodology are available [here](#)

2023 assured data includes:

Environmental

- Spills
- Water
- Waste

Emissions

- Scope 1
- Scope 2
- Scope 3, Category 1, Purchased goods and services
- Scope 3, Category 11, Use of sold products

Health and Safety

- Employee and contractor LTIFR
- LTIR (frequency) (OIFR)
- Fatalities

Metric	Units	2023	2022	2021
Revenue	millions of US dollars	33,135	28,091	22,929

CLIMATE ACTION^{1,2}

Metric	Units	FY2023	FY2022	FY2019 Baseline
CO₂e Emitted				
Scope 1	thousands of metric tons	1,469	1,483	1,668
Scope 2 – Location Based	thousands of metric tons	397	401	Not available
Scope 2 – Market Based	thousands of metric tons	295	312	650
Scope 1 and 2	thousands of metric tons	1,764	1,795	2,318
Scope 3	thousands of metric tons	35,091	34,849	44,384
Total Emissions (Scopes 1, 2, and 3)	thousands of metric tons	36,855	36,644	46,703

Scope 3 Categories

1. Purchased goods and services	thousands of metric tons CO ₂ e	7,199	6,747	6,280
2. Capital goods	thousands of metric tons CO ₂ e	113	94	105
3. Fuel- and energy related activities (not included in scope 1 or scope 2)	thousands of metric tons CO ₂ e	74	90	66
4. Upstream transportation and distribution	thousands of metric tons CO ₂ e	1,041	928	603
5. Waste generated in operations	thousands of metric tons CO ₂ e	95	65	129
6. Business travel	thousands of metric tons CO ₂ e	136	123	165
7. Employee commuting	thousands of metric tons CO ₂ e	69	58	100
8. Upstream leased assets	thousands of metric tons CO ₂ e	841	743	1,056
9. Downstream transportation and distribution	thousands of metric tons CO ₂ e	1	1	2
10. Processing of sold products	thousands of metric tons CO ₂ e	Not relevant	Not relevant	Not relevant
11. Use of sold products	thousands of metric tons CO ₂ e	20,407	19,825	28,385
12. End-of-life treatment of sold products	thousands of metric tons CO ₂ e	92	122	640
13. Downstream leased assets	thousands of metric tons CO ₂ e	2,741	3,505	3,435
14. Franchises	thousands of metric tons CO ₂ e	Not relevant	Not relevant	Not relevant
15. Investments	thousands of metric tons CO ₂ e	2,281	2,549	3,419

GHG Emissions Intensity

GHG emissions intensity – Scopes 1 and 2	metric tons of CO ₂ e per thousand US dollars of revenue	0.054	0.064	0.070
GHG emissions intensity – Scope 3	metric tons of CO ₂ e per thousand US dollars of revenue	1.075	1.241	1.348
Total GHG emission intensity	metric tons of CO ₂ e per thousand US dollars of revenue	1.129	1.304	1.419

Energy and Fuels

		FY2023	FY2022	FY2021
Total energy consumption	thousands of MWh	7,345	7,240	7,194
Purchased energy (electricity use, hot water, chilled water)	thousands of MWh	811	939	1,081
Fuel used – natural gas	thousands of MWh	2,161	1,791	2,677
Fuel used – oil and diesel	thousands of MWh	4,209	4,510	3,435

2023 Performance Data continued

NATURE

Metric	Units	FY2023	FY2022	FY2021
Water				
Water use	thousands of cubic meters	3,726	3,604	3,625
Total water recycled	thousands of cubic meters	144	167	186
Percentage of water recycled	percentage	45	43	42
Total waste water	thousands of cubic meters	323	383	443
Waste³				
Total waste generated	thousands of metric tons	114	109	110
Total waste recycled	thousands of metric tons	42	39	28
Site Activity				
Number of ISO 14001 certified sites	number of sites	87	73	73
Volume of hydraulic fracturing fluid used ⁴	thousands of cubic meters	12,557	Not available	Not available
Number of industry-recognized incidents >1 bbl of oil	-	7	5	15
Hydrocarbon bulk fluids spilled ⁵	number of barrels	209	102	3,670
Number of sites that are subject to environmental audit requirements	number of sites	532	540	545
Percentage of sites that are subject to environmental audit requirements	percentage	16	14	13

PEOPLE

Metric	Units	FY2023	FY2022	FY2021
Corporate giving: in-kind commercial initiatives	Approximate number of software licenses donated	85,000	62,000	68,000
Health and Safety				
Company's health & safety system certified to OHSAS 18001 or ISO 45001	percentage	1	1	1
Number of employees trained on HAZWOPER	approximate number of employees	7,200	7,300	4,000
Fatalities: employee	-	0	1	2
Fatalities: contractor	-	0	2	3
Fatalities: company total	-	0	3	5
Fatalities: third party	-	1	3	0
Fatalities: Fatal Accident Rate	per 100 million work hours	0	0.90	1.72
Automotive Accident Rate (Employees + Contractors)	per million miles	0.26	0.22	0.21
% data coverage as % of employee work hours for injury and illness	percentage	100	100	100
% data coverage as % of contractor work hours for injury and illness	percentage	100	100	100
Total hours worked: employees	-	245,240,750	227,669,940	230,271,210
Total Recordable Incidents (Employees + Contractors)	-	216	197	219
Total Recordable Incident Rate (Frequency) (Employees + Contractors)	per million work hours	0.59	0.59	0.75
Total Recordable Incident Rate (Frequency) (Employees)	per million work hours	0.64	0.59	0.75
Lost Time Incident Rate (Frequency) (Employees + Contractors)	per million work hours	0.32	0.32	0.45
Total Recordable Injury Rate (Frequency) (Employees + Contractors)	per million work hours	0.58	0.59	0.75
Lost Time Injury Rate (Frequency) (LTIFR) – Employees	per million work hours	0.35	0.33	0.42
Lost Time Injury Events (Lost Work Day Cases + Fatalities): Employees	number of events	85	74	87
Lost Time Injury Rate (Frequency) (LTIFR) – Contractors	per million work hours	0.26	0.30	0.52
Lost Time Illness Rate (Frequency) (OIFR): Employees	per million work hours	0.004	0.009	0.009
Training				
Average training hours per employee	hours	79	74	48
Number of training days	days	674,222	570,552	366,372
NExT training: professionals trained	-	16,900+	16,100+	16,000+
NExT training: classes held worldwide	-	2,000+	2,200+	1,700+
NExT training: practical courses and programs	-	700+	680+	700+
Ethics and Compliance training: annual training for all employees and contractors	percentage	93	94	94

2023 Performance Data continued

PEOPLE CONTINUED

Metric	Units	FY2023	FY2022	FY2021
Diversity, Equity, and Inclusion				
Nationality mix: Latin America	percentage	17	16	15
Nationality mix: North America	percentage	12	13	13
Nationality mix: Middle East & Asia	percentage	33	33	39
Nationality mix: Europe & Africa	percentage	38	38	33
Percentage of revenue by region: Latin America	percentage	21	20	19
Percentage of revenue by region: North America	percentage	21	21	19
Percentage of revenue by region: Middle East & Asia	percentage	31	32	36
Percentage of revenue by region: Europe & Africa	percentage	27	27	25
Percentage of revenue by region: Other	percentage	–	1	1
Women in company (total – excluding contractors) ⁶	percentage	20.2	19.5	18.7
Salaried positions held by women	percentage	24.6	23.8	22.9
Overall management positions held by women	percentage	22.7	22.0	21.6
Junior management positions held by women	percentage	24.5	24.0	23.8
Middle management positions held by women	percentage	19.2	18.5	17.9
Senior management positions held by women	percentage	22.7	20.9	18.0
Human Capital				
SLB global workforce	approximate number of persons	111,000	99,000	92,000
Salaried workforce	approximate number of persons	67,000	63,000	58,000
Bargaining agreement or union employee coverage	percentage	>23	>21	>21
Local talent	percentage	80	82	83
Total number of full time new employee hires	approximate number	11,500	12,500	10,000
Employee voluntary attrition	percentage	5.7	6.9	6.2
Employees with a performance appraisal record	approximate number	60,000	80,000	70,000
Engage to Excel participation	percentage	92	91	90
Engage to Excel engagement score	percentage positive	74	70	67
Engage to Excel manager effectiveness score	percentage positive	78	78	76
Engage to Excel inclusion index score	percentage positive	74	72	Not available
Engage to Excel performance enablement score	percentage positive	78	77	77
Tenure with company: <1 year	approximate number	10,500	10,000	8,000
Tenure with company: ≥1 year <5 years	approximate number	24,000	9,000	9,000
Tenure with company: ≥5 years <10 years	approximate number	17,000	18,000	19,000
Tenure with company: ≥10 years <15 years	approximate number	19,000	18,500	19,000
Tenure with company: ≥15 years <20 years	approximate number	15,000	13,000	13,000
Tenure with company: ≥20 years	approximate number	9,500	9,000	9,000

SUPPLY CHAIN

Metric	Units	FY2023	FY2022	FY2021
General Supply Chain Metrics				
Critical suppliers with spend	number of suppliers	1,160	1,045	983
% of total spend on critical suppliers	percentage	23	19	18
SM Level 1 suppliers with spend	number of suppliers	513	503	643
% of total spend on SM Level 1 suppliers	percentage	25	20	20
Total suppliers with spend	number of suppliers	38,114	37,388	38,025
Critical suppliers for which more than 40% of their revenue comes from SLB	percentage	8	6	7
Spend analysis covers 100% of suppliers with spend	percentage	100	100	100
% of spend covered in supplier risk analysis	percentage	91	90	71
% of suppliers considered high risk ⁷	percentage	<1	<1	<1
Supplier audits conducted	number of audits	2,550	2,865	1,489
% of audited suppliers with a documented development plan	percentage	45	34	80
US Supplier Diversity Program				
Diverse suppliers used: certified diverse	number of suppliers	177	160	144
Diverse suppliers used: classified/self-reported diverse	number of suppliers	1,099	1,108	988
Diverse suppliers used: total	number of suppliers	1,276	1,268	1,132
Spend on diverse suppliers: certified diverse	millions of US dollars	67	62	51
Spend on diverse suppliers: classified/self-reported diverse	millions of US dollars	398	403	287
Diversity percentage of total spend	percentage	8.9	9.6	9.7
CDP Supply Chain Engagements				
Total suppliers engaged in CDP Supply Chain Program	number of suppliers	1,354	1,240	496
Total responsive suppliers	number of suppliers	1,124	893	215
SLB supplier response rate	percentage	83	72	43
Average CDP member response rate	percentage	59	64	67
% of prior year's spend that engaged suppliers represent	percentage	54	50	35
Total scope 3 upstream emissions covered by engaged suppliers	percentage	61	58	42

- Our 2023 reporting of Scope 1 and 2 emissions at our operational facilities include estimates for energy consumption where no actual data was available. These estimates were made based on actual usage for the comparable period in the prior year or actual data for an operational facility of similar size and operations.
- On October 2, 2023, SLB completed the acquisition of the Aker Solutions subsea business. All emissions and revenue attributable to this acquired business are excluded from our 2023 GHG emissions reporting.
- In 2022, we adjusted our waste reporting period from 1 January–31 December to 1 October–30 September.
- As a result of improvements in our processes and internal measurement systems, we identified inaccuracies in our prior calculations of volume of hydraulic fracturing fluid used in 2022 and 2021. As a result, this data has been removed from the 2023 Sustainability Report.
- Hydrocarbon Bulk Fluids Spilled is defined as greater than one barrel of any crude oil, diesel, petrol/ gasoline, marine fuel, diesel-based, drilling fluids, and other hydrocarbon-based liquids including hydrocarbon-based solvents released at a SLB operational facility, customer site, rig-site or other third-party location where the failure of SLB equipment, personnel or of a SLB contractor has resulted in the spill, which is uncontained and reaches the environment. An uncontained spill is defined as being spilled or released to the ground or natural environment (i.e., uncontained by an impervious surface or secondary containment structure).
- Includes salaried and non-salaried positions. Non-salaried positions refer to hourly-based.
- Supplier risk is evaluated based on probability of failure; supplier organization (conglomerate, public, private, family owned, individually owned); dependency on SLB; type of contract; visibility to supplier performance; and dependency on supplier.



Schlumberger Limited

42 Rue Saint-Dominique
75007 Paris
France

5599 San Felipe
Houston, Texas 77056
United States

62 Buckingham Gate
London SW1E 6AJ
United Kingdom

Parkstraat 83
2514 JG The Hague
The Netherlands

slb.com

Disclaimer

This report, as well as other statements we make, contain “forward-looking statements” within the meaning of the federal securities laws, which include any statements that are not historical facts. Such statements often contain words such as “expect,” “may,” “can,” “believe,” “predict,” “plan,” “potential,” “projected,” “projections,” “precursor,” “forecast,” “outlook,” “expectations,” “estimate,” “intend,” “commit,” “pledge,” “anticipate,” “aim,” “ambition,” “goal,” “target,” “scheduled,” “think,” “should,” “could,” “would,” “will,” “see,” “likely,” and other similar words. Forward-looking statements address matters that are, to varying degrees, uncertain, such as statements about our goals, plans and projections with respect to sustainability and environmental matters; financial and performance targets and other forecasts or expectations regarding, or dependent on, our business outlook; growth for SLB as a whole and for each of its Divisions (and for specified business lines, geographic areas, or technologies within each Division); forecasts or expectations regarding energy transition and global climate change; improvements in operating procedures and technology; our business strategies and the strategies of our customers, including their respective decarbonization strategies; future global economic and geopolitical conditions; future liquidity, including free cash flow; and future results of operations, such as margin levels. These statements are subject to risks and uncertainties, including, but not limited to, changing global economic and geopolitical conditions; the results of operations and financial condition of our customers and suppliers; the inability to achieve our financial and performance targets and other forecasts and expectations; the inability to achieve our net-zero carbon emissions goals or interim emissions reduction goals; the inability to meet workforce expectations and perform at desired ESG and stewardship standards; general economic, geopolitical, and business conditions in key regions of the world; the ongoing conflict in Ukraine; foreign currency risk; inflation; pricing pressure; weather and seasonal factors; unfavorable effects

of health pandemics; availability and cost of raw materials; operational modifications, delays, or cancellations; challenges in our supply chain; production declines; the extent of future charges; the inability to recognize efficiencies and other intended benefits from our business strategies and initiatives, such as digital or SLB New Energy, as well as our cost reduction strategies; changes in government regulations and regulatory requirements, including those related to offshore oil and gas exploration, radioactive sources, explosives, chemicals, and climate-related initiatives; the inability of technology to meet new challenges in sustainability and exploration; the competitiveness of alternative energy sources or product substitutes; and other risks and uncertainties detailed in our most recent Forms 10-K, 10-Q, and 8-K filed with or furnished to the Securities and Exchange Commission. If one or more of these or other risks or uncertainties materialize (or the consequences of any such development changes), or should our underlying assumptions prove incorrect, actual results or outcomes may vary materially from those reflected in our forward-looking statements. Forward-looking statements are aspirational and not guarantees or promises that goals or targets will be met. Forward-looking and other statements in this report regarding our environmental, social and other sustainability plans and goals are not an indication that these statements are necessarily material to investors or required to be disclosed in our filings with the SEC. In addition, historical, current, and forward-looking environmental, social and sustainability-related statements may be based on standards for measuring progress that are still developing, internal controls and processes that continue to evolve, and assumptions that are subject to change in the future. The forward-looking statements in this report speak only as of February 23, 2024, and SLB disclaims any intention or obligation to update publicly or revise such statements, whether as a result of new information, future events or otherwise.

† For definitions of adjusted EBITDA and free cash flow, as well as reconciliations of these non-GAAP measures to their most comparable GAAP measures, please see our fourth-quarter and full-year 2023 results earnings press release [here](#). These non-GAAP financial measures should be considered in addition to, not as a substitute for or superior to, other measures of financial performance prepared in accordance with GAAP.